

P I X S Y S
elettronica



**- REGOLATORE
- CONTROLLER**

ATR142

**Manuale Installatore
User Manual**

Summary

1	Introduction	3
2	Model Identification.....	3
3	Technical Data.....	4
3.1	General Features.....	4
3.2	Hardware Features.....	4
3.3	Software Features	5
4	Dimensions and Installation.....	5
5	Electrical wirings.....	6
5.1	Wiring diagram	6
6	Display and Key Functions	9
6.1	Numeric Indicators (Display)	9
6.2	Meaning of Status Lights (Led)	10
6.3	Keys.....	10
7	Controller Functions.....	11
7.1	Modifying Main Setpoint and Alarm Setpoint Values	11
7.2	Auto-Tune	11
7.3	Manual Tuning.....	11
7.4	Automatic Tuning.....	12
7.5	Soft Start.....	12
7.6	Automatic/Manual Regulation for % Output Control	12
7.7	Pre-Programmed Cycle	13
7.8	Memory Card (optional).....	14
7.9	Loading default values.....	15
8	LATCH ON Functions	15
8.1	Digital Input Functions	17
8.2	Dual Action Heating-Cooling	18
9	Serial Communication.....	20
9.1	Slave.....	20
9.2	Master.....	24
10	Configuration	26
10.1	Modify Configuration Parameter.....	26
11	Table of Configuration Parameters.....	27
12	Alarm Intervention Modes.....	39
13	Table of Anomaly Signals.....	44
14	Summary of Configuration parameters.....	45

1 Introduction

Thank you for choosing a Pixsys controller.

With the ATR142 model Pixsys makes available in a single device all the resources relevant to sensor input and actuators command, in addition to the extended power range 24...230 Vac/Vdc. With 17 sensors to select and outputs configurable as relay or SSR command, the user or retailer can reduce warehouse stock by rationalising investment and device availability. The series is completed with models equipped with serial communication RS485 Modbus. The configuration is further simplified by the Memory cards which are equipped with internal battery and therefore don't require cabling to power the controller.

2 Model Identification

The range of ATR142 controllers comes in two versions. Refer to the table below to easily select your preferred model.

Models available, with power 24...230 Vac/Vdc +/-15% 50/60Hz – 3,5VA	
ATR142-ABC	2 relays (8A+5A) + 1 Ssr
ATR142-ABC-T	1 relays 8A + 1 Ssr + Rs485

3 Technical Data

3.1 General Features

<i>Displays</i>	4 0.40 inch displays + 4 0.30 displays
<i>Operating temperature</i>	0-45°C, humidity 35..95uR%
<i>Sealing</i>	IP65 front panel (with gasket) IP30 casing and IP20 terminals
<i>Material</i>	Polycarbonate UL94V0 self-extinguishing
<i>Weight</i>	100 g

3.2 Hardware Features

<i>Analogue input</i>	1: AN1 Configurable via software Input Thermocouple type K, S, R, J Automatic compensation of cold junction from 0°C to 50°C. Thermoresistance: PT100, PT500, PT1000, Ni100, PTC1K, NTC10K (β 3435K) Linear: 0-10V, 0-20 or 4-20mA, 0-40mV Potentiometers: 6K Ω , 150K Ω ,	Tolerance (25°C) +/-0.2 % \pm 1 digit for thermocouple input, thermo resistance and V/mA. Cold junction accuracy 0.1°C/°C
<i>Relay output</i>	2 relays (Atr142-ABC) 1 relay (Atr142-ABC-T) Configurable as command and/or alarm output	Contacts: Q1 – 8A-250V~ Q2 – 5A-250V~
<i>SSR output</i>	1 SSR Configurable as command output and/or alarm output.	12Vdc/30mA
<i>Supply</i>	Power supply 24..230 Vac/Vdc +/-15% 50/60Hz	Power consumption 3.5VA

3.3 Software Features

<i>Regulation algorithms</i>	ON-OFF with hysteresis. P, PI, PID, PD with proportional time
<i>Proportional band</i>	0...9999°C or °F
<i>Integral time</i>	0,0...999,9 sec (0 excluded)
<i>Derivative time</i>	0,0...999,9 sec (0 excluded)
<i>Controller functions</i>	Manual or automatic Tuning, configurable alarms, protection of command and alarm setpoints, activation of functions via digital input, preset cycle with Start/Stop.

4 Dimensions and Installation

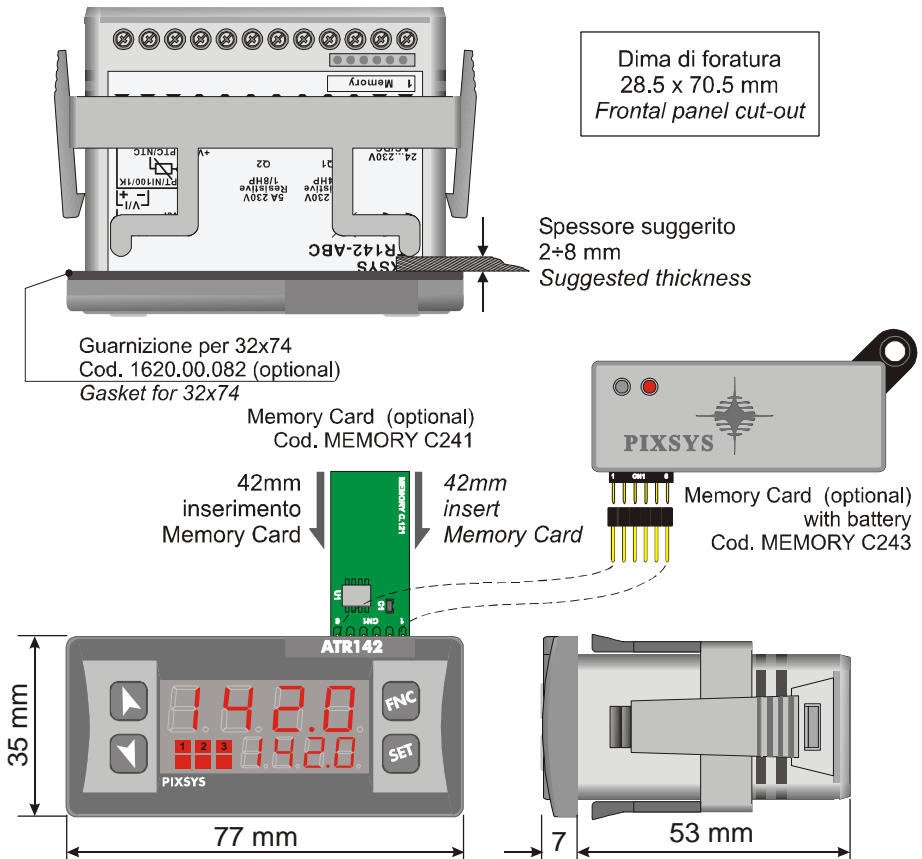

5 Electrical wirings



Although this controller was designed to resist noises in industrial environments, please notice following safety guidelines:

- Separate the feeder line from the power lines.
- Avoid placing near units with remote control switches, electromagnetic contactors, high powered motors and in all instances use specific filters.
- Avoid placing near power units, particularly if phase controlled.

5.1 Wiring diagram

The connections are reported below for the three models available.

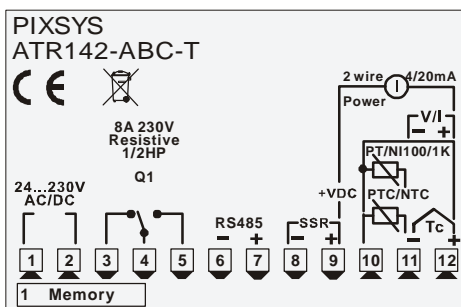
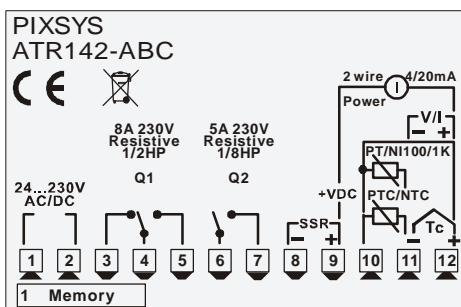

Power



Switching power supply with extended range

24...230 Vac/dc $\pm 15\%$ 50/60Hz – 5,5VA.

AN1 Analogue Input

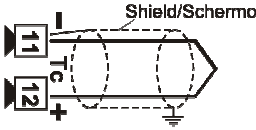

For thermocouples K, S, R, J.

- Comply with polarity
- For possible extensions, use a compensated wire and terminals suitable for the thermocouples used (compensated)
- When shielded cable is used, it should be grounded at one side only

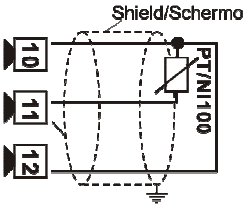

For thermoresistances PT100, NI100

- For the three-wire connection use wires with the same section
- For the two-wire connection short-circuit terminals 10 and 12
- When shielded cable is used, it should be grounded at one side only to avoid ground loop currents

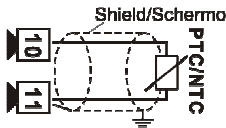
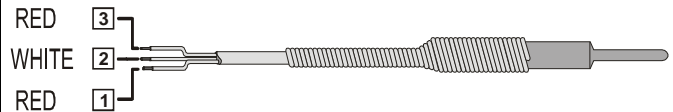

For thermoresistances NTC, PTC, PT500, PT1000 e potentiometers

- When shielded cable is used, it should be grounded at one side only to avoid ground loop currents

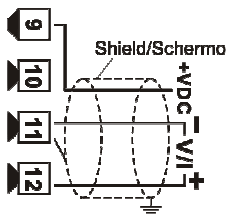

For linear signals V/mA

- Comply with polarity
- When shielded cable is used, it should be grounded at one side only to avoid ground loop currents

Examples of Connection for linear input

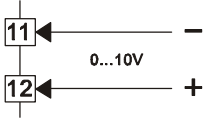

For signals 0...10V

Comply with polarity

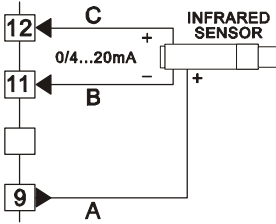

For signals 0/4...20mA with **three-wire sensor**

Comply with polarity

C=Sensor output

B=Sensor ground

A=Sensor power

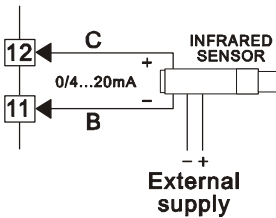

For signals 0/4...20mA with **external power of sensor**

Comply with polarity

A=Sensor output

B=Sensor ground

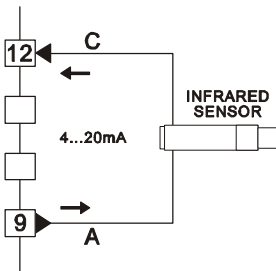

For signals 0/4...20mA with **two-wire sensor**

Comply with polarity

C=Sensor output

A=Sensor power supply

Serial input

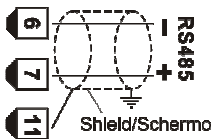

RS485 Modbus RTU communication

! Do not use LT (line termination) resistors

- For networks with more than five instruments supply in low voltage

Relay Q1 Output

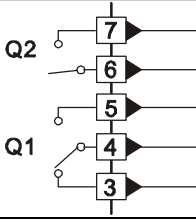

Capacity:

Q1 - 8A/250V~ for resistive loads

Q2 - 5A/250V~ for resistive loads

SSR output



SSR command output 12V/30mA

Digital Input on ATR243-20ABC



Digital input using parameter `dCt. ↓`.

The use of digital input in this version is possible only with TC sensors, 0...10V, 0/4...20mA and 0...40mV



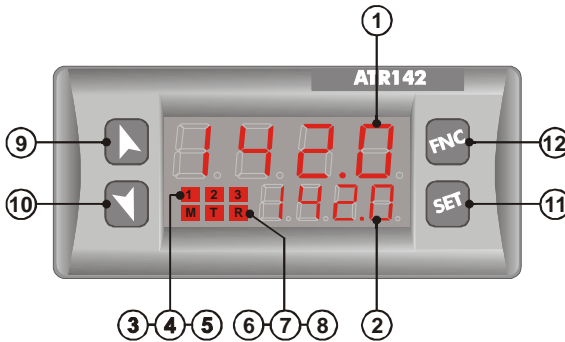



6 Display and Key Functions











6.1 Numeric Indicators (Display)

1		Normally displays the process. During the configuration phase, it displays the parameter being inserted.
2		Normally displays the setpoint. During the configuration phase, it displays the parameter value being inserted.

6.2 Meaning of Status Lights (Led)

3		ON when the output command is on. For motorised valve command, led in on when valve is opening and blink when closing.
4		ON when alarm 1 is on.
5		ON when alarm 2 is on.
6		ON when the “Manual” function is on.
7		ON when the controller is running an “Autotune” cycle.
8		ON when the controller communicates via serial port.





6.3 Keys

9		<ul style="list-style-type: none">• Allows to increase the main setpoint.• During the configuration phase, allows to slide through parameters. Together with the  key it modifies them.• Pressed after the  key it allows to increase the alarm setpoint.
10		<ul style="list-style-type: none">• Allows to decrease the main setpoint.• During the configuration phase, allows to slide through parameters. Together with the  key it modifies them.• Pressed after the  key it allows to decrease the alarm setpoint.
11		<ul style="list-style-type: none">• Allows to display the alarm setpoint and runs the autotuning function.• Allows to vary the configuration parameters.
12		<ul style="list-style-type: none">• Allows to display the alarm setpoint and runs the autotuning function.• Allows to vary the configuration parameters.

7 Controller Functions

7.1 Modifying Main Setpoint and Alarm Setpoint Values

The setpoint value can be changed from the keyboard as follows:

	Press	Effect	Operation
1	 or 	Value on display 2 changes	Increases or decreases the main setpoint
2		Visualize alarm setpoint on display 1	
3	 or 	Value on display 2 changes	Increases or decreases the alarm set point value



7.2 Auto-Tune

The Tuning procedure calculates the controller parameters and can be manual or automatic according to selection on parameter 46 `tune`.

7.3 Manual Tuning

The manual procedure allows the user greater flexibility to decide when to update PID algorithm work parameters. The procedure can be activated in two ways.

- **By running Tuning from keyboard:**

Press the  key until display 1 shows the writing `tune` with display 2 showing `off`, press , display 2 shows `on`. The **T** led switches on and the procedure begins.

- **By running Tuning from digital input:**

Select `tune` on parameter 50 `dge`.

On first activation of digital input (commutation on front panel) the **T** led switches on and on second activation switches off.

7.4 Automatic Tuning

Automatic tuning activates when the controller is switched on or when the setpoint is modified to a value over 35%.

To avoid an overshoot, the threshold where the controller calculates the new PID parameters is determined by the setpoint value minus the "Set Deviation Tune" (see Parameter 47 ).

To exit Tuning and leave the PID values unchanged, just press the



key until display 1 shows the writing  with the display

showing , press , display 2 shows .

The  led switches off and the procedure finishes.

7.5 Soft Start

To reach the setpoint the controller can follow a gradient expressed in units (e.g. degree/hour).

Set the increase value in parameter 51  with the desired units/hour; only **on subsequent activation** the controller uses the soft start function.

Automatic/manual tuning cannot be enabled if the Soft start is active.

7.6 Automatic/Manual Regulation for % Output Control

This function allows you to select automatic functioning or manual command of the output percentage.



With parameter 49 , you can select two methods.

1. **The first selection**  allows you to enable the

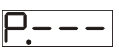

key with the writing  on display 1, while

display two shows .

Press the  key to show `MAN`; it is now possible, during the process display, to change the output percentage using the keys  and . To return to automatic mode, using the same procedure, select `Auto` on display 2: the `M` led switches off and functioning returns to automatic mode.

2. **The second selection** `ENST` enables the same functioning, but with two important variants:

- If there is a temporary lack of voltage or after switch-off, the manual functioning will be maintained as well as the previously set output percentage value.
- If the sensor breaks during automatic functioning, the controller moves to manual mode while maintaining the output percentage command unchanged as generated by the PID immediately before breakage.

7.7 Pre-Programmed Cycle

The pre-programmed cycle function activates by setting `PrCY` in parameter 48 `OPNa`.

The controller reaches setpoint1 basing on the gradient set in parameter 51 `GRAd`, then it reaches maximum power up to setpoint2. When the process reaches maximum power, this setpoint is maintained for the time set in parameter 52 `PRt`. On expiry, the command output is disabled and the controller displays `STOP`.

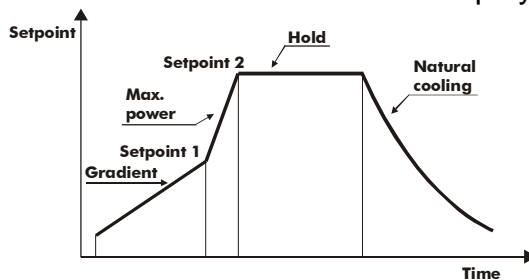

The cycle starts at each activation of the controller, or via digital input if it is enabled for this type of functioning (see parameter 50 `DCt`).

7.8 Memory Card (optional)



Parameters and setpoint values can be duplicated from one controller to another using the Memory card.

There are two methods:

- With the controller connected to the power supply

Insert the memory card **when the controller is off**.

On activation display 1 shows nEno and display 2 shows ----
(Only if the correct values are saved in the memory card). By

pressing the  key display 2 shows LOAD, then confirm using the  key. The controller loads the new data and starts again.



- With the controller not connected to power supply.

The memory card is equipped with an internal battery with an autonomy of about 1000 uses.

Insert the memory card and press the programming buttons.

When writing the parameters, the led turns red and on completing the procedure it changes to green. It is possible to repeat the procedure without any particular attention.

Updating Memory Card

To *update* the memory card values, follow the procedure described in the first method, setting display 2 to ---- so as not to load the parameters on controller².





Enter configuration and **change at least one parameter**.

Exit configuration. Changes are saved automatically.

² If on activation the controller does not display nEno it means no data have been saved on the memory card, but it is possible to update values.

7.9 Loading default values

This procedure makes it possible to restore factory settings of the instrument.

	Premere	Effetto	Eeguire
1	 for 3 seconds.	Display 1 shows 0000 with the 1st digit flashing, while display 2 shows PASS	
2	 or 	Change the flashing digit and move to the next one using the  key.	Enter password 9999
3	 to confirm	Instrument loads default settings	Turn off and on the instrument







8 LATCH ON Functions

For use with input **Pot.1** (potentiometer 6K Ω) and **Pot2** (potentiometer 150K Ω) and with linear input (0...10V, 0...40mV, 0/4...20mA), you can associate start value of the scale (parameter 6 **LoL**) to the minimum position of the sensor and value of the scale end (parameter 7 **uPL**) to the maximum position of the sensor (parameter 8 **LAEC**, configured as **Std**).

It is also possible to fix the point in which the controller will display 0 (however keeping the scale range between **LoL** and **uPL**) using the “virtual zero” option by setting **u0SE** or **u0in** in parameter 8 **LAEC**. If you set **u0in** the virtual zero will reset after each activation of the tool; if you set **u0SE** the virtual zero remains fixed once tuned.

To use the LATCH ON function configure as you wish the parameter **LATEC**.³

For the calibration procedure refer to the following table:

	Press	Effect	Operation
1		Exit parameters configuration. Display 2 shows the writing LATEC .	Position the sensor on the minimum functioning value (associated with LoL)
2		Set the value to minimum. The display shows LoU	Position the sensor on the maximum functioning position (associated with UPL)
3		Set the value to maximum. The display shows HIGH	To exit the standard procedure press  . For “virtual zero” settings position the sensor on the zero point.
4		Set the virtual zero value. The display shows U I F E . N.B.: for selection of U O I N the procedure in point 4 should be followed on each re-activation.	To exit the procedure press  .

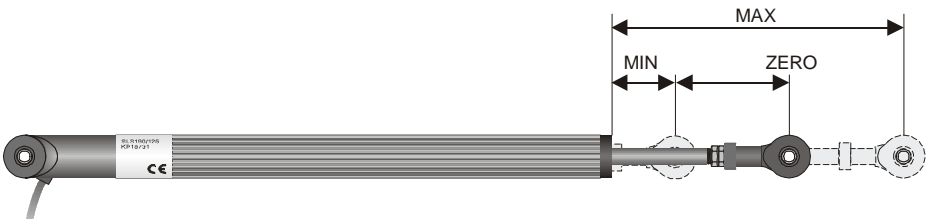

³ The tuning procedure starts by exiting the configuration after changing the parameter.
16

8.1 Digital Input Functions

Digital input is programmable for several functions which are useful to simplify controller operability. Select the desired function on parameter 50 `dCt.`.

1. Hold function (enabled by setting `Lcna` or `Lcnc`) allows to lock the reading of sensors when the digital input is active (useful for wide ranging oscillation on less significant values). During the lock phase, display 2 flashes and shows `Loct`.
2. Enables/disables the autotuning function from digital input if the parameter `tunE` is set on `NA.`.
3. Enable regulation with `rana` or `ranc`.
4. Switch from automatic to manual functioning if `AWNA` is set on `En.` or `EnSt.`.
5. Start of pre-programmed cycle (see paragraph 7.7) with `SESt.`.
6. Change setpoint function.
This function is useful where there are 2 to 4 working thresholds required during system functioning without having to press the arrow keys.

To enable the function use the parameter `oPna`, by selecting the number of setpoints desired (no. thresholds switch). They can be switched during functioning by pressing the  key.

N.B.:

The digital input functions **are not** available with sensors PT100, NI100, NTC, PTC, PT500, PT1000 e potentiometers.

8.2 Dual Action Heating-Cooling

ATR142 is also suitable also for systems requiring a combined heating-cooling action.

The command output must be configured as Heating PID ($\text{ACTE} = \text{HEAT}$ and with a PB greater than 0), and one of the alarms (AL. 1 or AL. 2) must be configured as COOL . The command output must be connected to the actuator responsible for heat, while the alarm will control cooling action.

The parameters to configure for the Heating PID are:

$\text{ACTE} = \text{HEAT}$ Command output type (Heating)

PB : Heating proportional band

Ti : Integral time of heating and cooling

Td : Derivative time of heating and cooling

tc : Heating time cycle

The parameters to configure for the Cooling PID are the following (example: action associated to alarm1):

$\text{AL. 1} = \text{COOL}$ Alarm1 selection (cooling)

PbN : Proportional band multiplier

owdb : Overlapping/Dead band

cotc : Cooling time cycle

The parameter PbN (that ranges from 1.00 to 5.00) determines the proportional band of cooling basing on the formula:

Cooling proportional band = $\text{PB} * \text{PbN}$

This gives a proportional band for cooling which will be the same as heating band if $\text{PbN} = 1.00$, or 5 times greater if $\text{PbN} = 5.00$.

The **integral time and derivative time** are the same for both actions.

The parameter owdb determines the percentage overlapping between the two actions. For systems in which the heating output and cooling output must never be simultaneously active a dead band ($\text{owdb} \leq 0$) must be configured, and vice versa you can configure an overlapping ($\text{owdb} > 0$).

The following figure shows an example of dual action PID (heating-cooling) with $E_i = 0$ and $E_d = 0$.

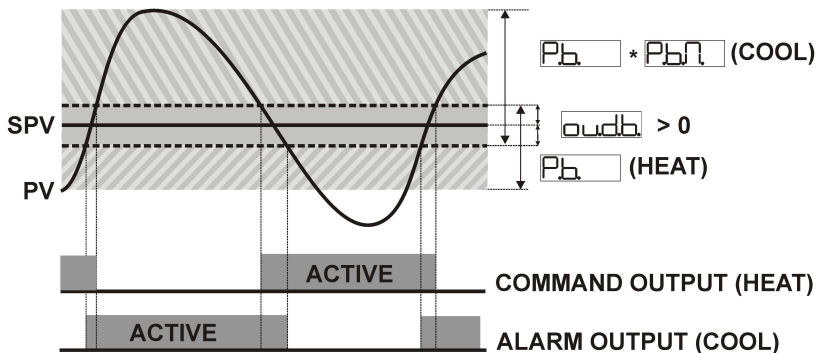
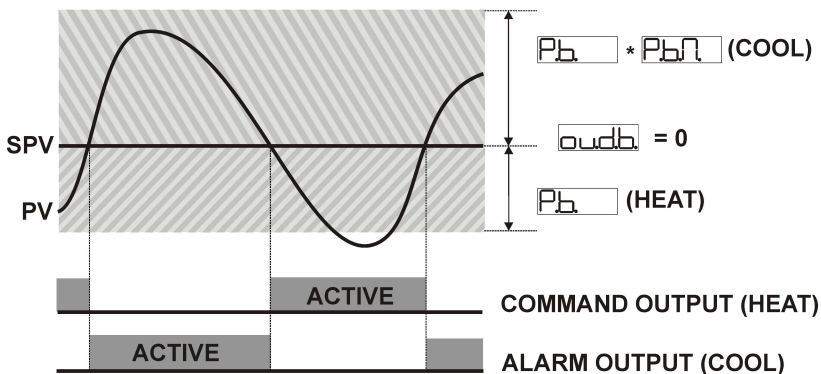
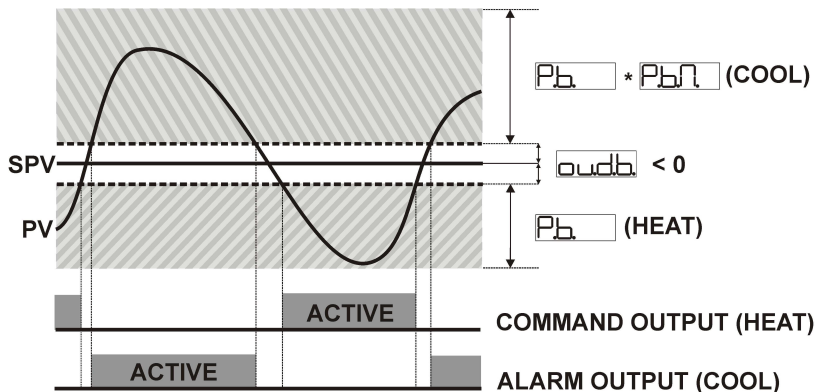

The parameter `catc` has the same meaning as the heating time cycle `tc`.

The parameter `coof` (cooling fluid) pre-selects the proportional band multiplier `Pbn` and the cooling PID time cycle `catc` basing on the type of cooling fluid:

<code>coof</code>	Cooling fluid type	<code>Pbn</code>	<code>catc</code>
<code>Air</code>	Air	1.00	10
<code>oil</code>	Oil	1.25	4
<code>H2O</code>	Water	2.50	2

Once selected, the parameter `coof`, the parameters `Pbn`, `oudb` and `catc` can however be changed.

9 Serial Communication

9.1 Slave

ATR142-ABC-T, equipped with RS485, can receive and broadcast data via serial communication using MODBUS RTU protocol. The device operates as slave if parameter 59 `NASE` is set as `DIS`. This function enables the control of multiple controllers connected to a supervisory system (SCADA).

Each controller responds to a master query only if the query contains the same address as that in the parameter `SLAd`. The addresses permitted range from 1 to 254 and there must not be controllers with the same address on the same line.

Address 255 can be used by the master to communicate with all the connected equipment (broadcast mode), while with 0 all the devices receive the command, but no response is expected.

ATR142 can introduce a delay (in milliseconds) in the response to the master request. This delay must be set on parameter 58 `SEdE`.

Each parameter change is saved by the controller in the EEPROM memory (100000 writing cycles), while the setpoints are saved with a delay of ten seconds after the last change.

NB: Changes made to words that are different from those reported in the following table can lead to malfunction.

Modbus RTU protocol features

<i>Baud-rate</i>	Can be selected on parameter 70 <input type="text" value="bdrt"/> <input type="text" value="48 F"/> 4800bit/sec <input type="text" value="96 F"/> 9600bit/sec <input type="text" value="192 F"/> 19200bit/sec <input type="text" value="288 F"/> 28800bit/sec <input type="text" value="384 F"/> 38400bit/sec <input type="text" value="576 F"/> 57600bit/sec
<i>Format</i>	8, N, 1 (8bit, no parity, 1 stop)
<i>Supported functions</i>	WORD READING (max 20 word) (0x03, 0x04) SINGLE WORD WRITING (0x06) MULTIPLE WORDS WRITING (max 20 word) (0x10)

The list below includes all the available addresses, where:

RO = Read Only





R/W = Read/Write

WO = Write Only

Modbus address	Description	Read Write	Reset value
0	Device type	RO	EEPROM
1	Software version	RO	EEPROM
5	Slave Address	R/W	EEPROM
6	Boot version	RO	EEPROM
50	Automatic addressing	WO	-
51	System code comparison	WO	-
1000	Process (with tenths of degree for temperature sensors; digits for linear sensors)	RO	?
1001	Setpoint1	R/W	EEPROM
1002	Setpoint2	R/W	EEPROM
1003	Setpoint3	R/W	EEPROM
1004	Setpoint4	R/W	EEPROM
1005	Alarm1	R/W	EEPROM
1006	Alarm2	R/W	EEPROM
1007	Setpoint gradient	RO	EEPROM

1008	Outputs status (0=off, 1=on) Bit 0 = Q1 relay Bit 1 = Q2 relay Bit 2 = SSR	RO	0
1009	Heating output percentage (0-10000)	RO	0
1010	Cooling output percentage (0-10000)	RO	0
1011	Alarms status (0=none, 1=active) Bit0 = Alarm 1 Bit1 = Alarm 2	RO	0
1012	Manual reset: write 0 to reset all the alarms. In reading (0=not resettable, 1=resettable): Bit0 = Alarm 1 Bit1 = Alarm 2	WO	0
1013	Error flags Bit0 = Eeprom writing error Bit1 = Eeprom reading error Bit2 = Cold junction error Bit3 = Process error (sensor) Bit4 = Generic error Bit5 = Hardware error	RO	0
1014	Cold junction temperature (tenths of degree)	RO	?
1015	Start/Stop 0=controller in STOP 1=controller in START	R/W	0
1016	Lock conversion ON/OFF 0=Lock conversion off 1=Lock conversion on	R/W	0
1017	Tuning ON/OFF 0=Tuning off 1=Tuning on	R/W	0
1018	Automatic/manual selection 0=automatic 1>manual	R/W	0
1019	OFF LINE ¹ time (milliseconds)	R/W	0
1100	Process visualized (decimal as display)	RO	?
1101	Setpoint1 visualized (decimal as display)	R/W	EEPROM
1102	Setpoint2 visualized (decimal as display)	R/W	EEPROM
1103	Setpoint3 visualized (decimal as display)	R/W	EEPROM
1104	Setpoint4 visualized (decimal as display)	R/W	EEPROM
1105	Allarme1 visualized (decimal as display)	R/W	EEPROM

¹ If value is 0, the control is disabled. If different from 0, it is the max. time which can elapse between two pollings before the controller goes off-line.
If it goes off-line, the controller returns to Stop mode, the control output is disabled but the alarms are active.

1106	Allarme2 visualized (decimal as display)	R/W	EEPROM
1107	Setpoint gradient (decimal as display)	RO	EEPROM
1108	Heating output percentage (0-1000)	RO	0
1109	Heating output percentage (0-100)	RO	0
1110	Cooling output percentage (0-1000)	RO	0
1111	Cooling output percentage (0-100)	RO	0
2001	Parameter 1	R/W	EEPROM
2002	Parameter 2	R/W	EEPROM
...
2060	Parameter 60	R/W	EEPROM
3000	Disabling serial control of machine ²	WO	0
3001	First word display1 (ASCII)	R/W	0
.....	R/W	0
3008	Eighth word display1 (ASCII)	R/W	0
3009	First word display2 (ASCII)	R/W	0
.....	R/W	0
3016	Eighth word display2 (ASCII)	R/W	0
3017	Word LED Bit 0 = LED 1 Bit 1 = LED 2 Bit 2 = LED 3 Bit 3 = LED MAN Bit 4 = LED TUN Bit 5 = LED REM	R/W	0
3018	Word keys (write 1 to command keys) Bit 0 =  Bit 1 =  Bit 2 =  Bit 3 = 	R/W	0
3019	Word serial outputs Bit 0 = Q1 relay Bit 1 = Q2 relay Bit 2 = SSR	R/W	0
3020	Word serial outputs state if off-line Bit 0 = Q1 relay Bit 1 = Q2 relay Bit 2 = SSR	R/W	0
3021	Word serial process	R/W	0

² By writing 1 on this word, the effects of the writing are cancelled on all the Modbus addresses from 3001 to 3022. Control therefore returns to the controller.

9.2 Master

The device works as master if the value selected on parameter 59 **MASt.** is other than **dI5.**

9.2.1 Master Mode in retransmission

Selecting this mode, the device will write the value to be retransmitted at the address selected on parameter 60 **Addr.** of the slave devices having same ID as the value selected on parameter 57 **SLAd.**

Regarding retransmission of setpoint values, after writing the value on slaves, ATR142 starts reading the corresponding word, so that any modification of value on the slave will be automatically updated also on the Master. Two successive pollings will be delayed for the time selected on parameter 57 **SEdE.**

The following table includes the options allowing the Master mode in retransmission and the relevant retransmitted value.

MASt.	Descrizione
WPro. Write Process	Write process value
rWco. Read/Write Command Setpoint	Write and read command setpoint value
WouP. Write Output Percentage	Write output percentage rated by P.I.D. function (Range 0-10000)
rWA1. Read/Write Alarm 1	Write and read alarm 1 setpoint value

The read/written value might be rescaled according to the proportion described in the following table:

NASE	Limiti valore ingresso		Limiti valore riscaldato	
	Min.	Max.	Min.	Max.
UPro Write Process	LoLi Lower Limit Input	UPLi Upper Limit Input	LoLr Lower Limit Retransmission	UPLr Upper Limit Retransmission
rUco Read/Write Command Setpoint	LoLS Lower Limit Setpoint	UPLS Upper Limit Setpoint	LoLr Lower Limit Retransmission	UPLr Upper Limit Retransmission
UouP Write Output Percentage	0	10000	LoLr Lower Limit Retransmission	UPLr Upper Limit Retransmission
rUA1 Read/Write Alarm 1 Setpoint	LoLS Lower Limit Setpoint	UPLS Upper Limit Setpoint	LoLr Lower Limit Retransmission	UPLr Upper Limit Retransmission

The input value (included between minimum and max limit) is linearly converted into the retransmitted value which is included between min and max output value.

Rescaling is not executed if parameters **LoLr** and **UPLr** have the same value.

9.2.2 Master Mode Remote process















To enable this function it is necessary to select **rPro** on parameter 59 **NASE**. In this mode the process value on ATR142 is a value read via serial communication. The ID of the slave must be same as value selected on parameter 57 **SLAd** and the word to read is selected on parameter 60 **Addr**. Two successive pollings will be delayed for the time selected on parameter 57 **SEdE**. The read value might be rescaled according to the proportion described in the following table:

NASE	Limits of read value		Limits of rescaled value	
	Min.	Max.	Min.	Max.
rPro Read Process	LoLr Lower Limit Retransmission	UPLr Upper Limit Retransmission	LoLi Lower Limit Input	UPLi Upper Limit Input

10 Configuration

10.1 Modify Configuration Parameter

For configuration parameters see paragraph 11.

	Press	Effect	Operation
1	 for 3 seconds.	Display 1 shows  with the 1st digit flashing, while display 2 shows  .	
2	 or 	Change the flashing digit and move to the next one using the  key.	Enter password 
3	 to confirm	Display 1 shows the first parameter and display 2 shows the value.	
4	 or 	Slide up/down through parameters	
5	 +  or 	Increase or decrease the value displayed by pressing firstly  and then an arrow key.	Enter the new data which will be saved on releasing the keys. To change another parameter return to point 4.
6		End of configuration parameter change. The controller exits from programming.	

11 Table of Configuration Parameters

The following table includes all parameters. Some of them will not be visible on the models which are not provided with relevant hardware features.

no.	Display	Parameter description	Entering range
1	<div style="border: 1px solid black; padding: 2px; display: inline-block;">c.out</div> Command Output	Select command output type	<div style="display: flex; flex-direction: column; gap: 5px;"> <div style="border: 1px solid black; padding: 2px; display: inline-block;">c. 02</div> <div style="border: 1px solid black; padding: 2px; display: inline-block;">c. 01</div> <div style="border: 1px solid black; padding: 2px; display: inline-block;">c.SSf</div> <div style="border: 1px solid black; padding: 2px; display: inline-block;">c.uAL.</div> </div> Default

























ATR142-ABC			
	<i>COMMAND</i>	<i>ALARM 1</i>	<i>ALARM 2</i>
<div style="border: 1px solid black; padding: 2px; display: inline-block;">c. 02</div>	Q2	Q1	SSR
<div style="border: 1px solid black; padding: 2px; display: inline-block;">c. 01</div>	Q1	Q2	SSR
<div style="border: 1px solid black; padding: 2px; display: inline-block;">c.SSf</div>	SSR	Q1	Q2
<div style="border: 1px solid black; padding: 2px; display: inline-block;">c.uAL.</div>	Q1(opens) Q2(closes)	SSR	-



ATR142-ABC-T		
	<i>COMMAND</i>	<i>ALARM 1</i>
<div style="border: 1px solid black; padding: 2px; display: inline-block;">c. 01</div>	Q1	SSR
<div style="border: 1px solid black; padding: 2px; display: inline-block;">c.SSf</div>	SSR	Q1
<div style="border: 1px solid black; padding: 2px; display: inline-block;">c.uAL.</div>	Q1(opens) SSR(closes)	-















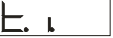
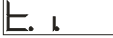

no.	Display	Parameter description	Entering range
2	SEn Sensor	Analog input configuration	Tc-K (-260...1360°C) (Default) Tc-S (-40...1760°C) Tc-R (-40...1760°C) Tc-J (-200...1200°C) PT100 (-200...600°C) PT100 (-200...140°C) NI100 (-60...180°C) NTC10K (-40...125°C) PTC1K (-50...150°C) PT500 (-100...600°C) PT1000 (-100...600°C) 0...10Volt 0...20mA 4...20mA 0...40mVolt Pot. max 6Kohm Pot. max 150Kohm
3	dP. Decimal Point	Select number of displayed decimal points	0 Default 00 000 0000
4	LdLS Lower Limit Setpoint	Lower limit setpoint	-999...+9999 digit* (degrees if temperature) Default: 0.
5	UPLS Upper Limit Setpoint	Upper limit setpoint	-999...+9999 digit* (degrees if temperature) Default: 1750.

* The display of the decimal point depends on the setting of parameter SEn

and the parameter dP..

no.	Display	Parameter description	Entering range
6	 Lower Linear Input	Lower range limit An1 only for linear input	-999...+9999 digit* Default: 0.
7	 Upper Linear Input	Upper range limit An1 only for linear input	-999...+9999 digit* Default: 1000.
8	 LATCH On Function	Automatic setting of limits for Linear input	 (Disabled) Default  (Standard)  (Virtual Zero Stored)  (Virtual Zero Initialized)
9	 Offset Calibration	Offset calibration Number added to displayed value of process (normally corrects the room temperature value)	-999...+1000 digit* for linear sensors and potentiometers. -200.0...+100.0 tenths for temperature sensors. Default: 0.0.
10	 Gain Calibration	Gain calibration Value multiplied with process value to perform calibration on working point	-10.0%...+10.0% Default: 0.0.
11	 Action type	Regulation type	 : Heating (N.O.) Default  : Cooling (N.C.)  : HEat Off Over Setpoint
12	 Command Reset	Type of reset for state of command contact (always automatic in PID functioning)	 (Automatic Reset) Default  (Manual Reset)  (Manual Reset Stored)
13	 Command State Error	State of contact for command output in case of error	 Default 
14	 Command Led	State of the OUT1 led corresponding to the relevant contact	  Default
15	 Command Hysteresis	Hysteresis in ON/OFF or dead band in P.I.D.	-999...+999 digits* (tenths of degree if temperature) Default: 0.0.

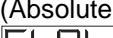
* The display of the decimal point depends on the setting of parameter  and parameter .

no.	Display	Parameter description	Entering range
16	 Command Delay	Command delay (only in ON/OFF functioning). (In case of servo valve it also functions in PID and represents the delay between the opening and closure of the two contacts)	-180...+180 seconds (tenths of second in case of servo valve). Negative: delay in switching off phase. Positive: delay in activation phase. Default: 0.
17	 Command Setpoint Protection	Allows or not to change the command setpoint value	 Default 
18	 Proportional Band	Proportional band Process inertia in units (E.g.: if temperature is in °C)	0 on/off if  equal to 0 . Default 1-9999 digit* (degrees if temperature)
19	 Integral Time	Integral time. Process inertia in seconds	0.0-999.9 seconds (0 integral disabled) Default: 0.
20	 Derivative Time	Derivative time. Normally ¼ the integral time	0.0-999.9 seconds (0 derivative disabled) Default: 0.
21	 Cycle Time	Cycle time (for PID on remote control switch 10/15sec, for PID on SSR 1 sec) or servo time (value declared by servomotor manufacturer)	0.1-300.0 seconds Default: 10.0. For motorised valve minimum time in 1.0.
22	 Output Power Limit	Limit of output power %	10-100 % Default: 100.
23	 Alarm 1	Alarm 1 selection. Intervention of the alarm is associated with AL1	 (Disabled) Default  (Absolute Alarm)  (Band Alarm)  (High Deviation Alarm)  (Low Deviation Alarm)  (Absolute Command setpoint Alarm)  (Start Alarm) Active in Run  (Cooling)

no.	Display	Parameter description	Entering range
24	A. ISa Alarm 1 State Output	Alarm 1 output contact and intervention type	no S (n.o. start) Default Normally open, active at start nc S (n.c. start) Normally closed, active at start no E (n.o. threshold) Normally open, active on reaching alarm ⁴ nc E (n.c. threshold) Normally closed on reaching alarm ⁴
25	A. RE Alarm 1 Reset	Type of Reset for contact of alarm 1	A-E (Automatic Reset) Default n-E (Manual Reset) n-E.S (Manual Reset Stored)
26	A. SE Alarm 1 State Error	State of contact for alarm 1 output in case of error	ca Default cc
27	A. LD Alarm 1 Led	State of the OUT2 led corresponding to the relative contact	ca cc Default
28	A. HY Alarm 1 Hysteresis)	Alarm 1 hysteresis	-999...+999 digit* (tenths of degree if temperature). Default: 0.
29	A. DE Alarm 1 Delay	Alarm 1 delay	-180...+180 Seconds Negative: delay in alarm output phase. Positive: delay in alarm entry phase. Default: 0.
30	A. SP. Alarm 1 Setpoint Protection	Alarm 1 set protection. Does not allow user to modify setpoint	FrEE Default LoCt H dE

⁴ On activation, the output is inhibited if the controller is in alarm mode. Activates only if alarm condition reappears, after that it was restored.



* The display of the decimal point depends on the setting of parameter **SEn** and parameter **dP**.













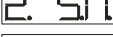
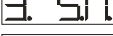
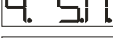
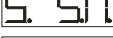

no.	Display	Parameter description	Entering range
31	AL 2 Alarm 2	Alarm 2 selection. Alarm intervention is associated with AL2	<div style="display: flex; flex-direction: column; gap: 5px;"> <div>dis (Disabled) Default</div> <div>AL (Absolute Alarm)</div> <div>BL (Band Alarm)</div> <div>HdAL (High Deviation Alarm)</div> <div>LdAL (Low Deviation Alarm)</div> <div>AcAL (Absolute Command setpoint Alarm)</div> <div>StAL (Start Alarm)</div> <div>COOL (Cooling)</div> </div>
32	A2So Alarm 2 State Output	Alarm 2 output contact and intervention type	<div style="display: flex; flex-direction: column; gap: 5px;"> <div>no S (n.o. start) Default Normally open, active at start</div> <div>nc S (n.c. start) Normally closed, active at start</div> <div>no t (n.o. threshold) Normally open, active on reaching alarm⁵</div> <div>nc t (n.c. threshold) Normally closed, active on reaching alarm⁵</div> </div>
33	A2rE Alarm 2 Reset	Type of Reset for contact of alarm 2	<div style="display: flex; flex-direction: column; gap: 5px;"> <div>ArE (Automatic Reset) Default</div> <div>MrE (Manual Reset)</div> <div>MrES (Manual Reset Stored)</div> </div>
34	A2SE Alarm 2 State Error	State of contact for alarm 2 output in case of error	<div style="display: flex; flex-direction: column; gap: 5px;"> <div>CO Default</div> <div>CC</div> </div>
35	A2Ld Alarm 2 Led	State of OUT2 led corresponding to relative contact	<div style="display: flex; flex-direction: column; gap: 5px;"> <div>CO</div> <div>CC Default</div> </div>
36	A2HY Alarm 2 Hysteresis	Alarm 2 hysteresis	-999...+999 digit* (tenths of degree if temperature). Default: 0.



⁵ On activation, the output is inhibited if the controller is in alarm mode. It activates only if alarm condition reappears after that it was restored.















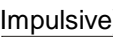







no.	Display	Parameter description	Entering range
37	A2dE. Alarm 2 Delay	Alarm 2 delay	-180...+180 Seconds Negative: delay in alarm output phase. Positive: delay in alarm entry phase. Default: 0.
38	A2SP. Alarm 2 Setpoint Protection	Alarm 2 set protection. Does not allow operator to change value of setpoint	FrEE Default Loct HidE
39	COoF. Cooling Fluid	Type of cooling fluid	Air Default aIL H2o
40	PbN Proportional Band Multiplier	Proportional band multiplier	1.00-5.00 Default: 1.00.
41	oUdb. (Overlap/Dead Band)	Overlapping/Dead band	-20.0-50.0% Default: 0.
42	COtc. Cooling Cycle Time	Cycle time for cooling output	1-300 seconds Default: 10.

* The display of the decimal point depends on the setting of parameter **SEn** and parameter **dP**.

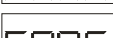
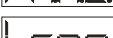
no.	Display	Parameter description	Entering range
43	 Conversion Filter	ADC filter: number of means on analog-digital conversions	(Disabled) (2 Samples Mean) (3 Samples Mean) (4 Samples Mean) (5 Samples Mean) (6 Samples Mean) (7 Samples Mean) (8 Samples Mean) (9 Samples Mean) (10 Samples Mean) Default (11 Samples Mean) (12 Samples Mean) (13 Samples Mean) (14 Samples Mean) (15 Samples Mean)
44	 Conversion Frequency	Frequency of sampling of analog-digital converter	(242 Hz) (123 Hz) (62 Hz) (50 Hz) (39 Hz) (33.2 Hz) (19.6 Hz) (16.7 Hz) Default (12.5 Hz) (10 Hz) (8.33 Hz) (6.25 Hz) (4.17 Hz)

no.	Display	Parameter description	Entering range
45	 Visualisation Filter	Visualisation filter	 (Disabled) Default  (Pitchfork filter)  (First Order)  (First Order with Pitchfork)  (2 Samples Mean)  (3 Samples Mean)  (4 Samples Mean)  (5 Samples Mean)  (6 Samples Mean)  (7 Samples Mean)  (8 Samples Mean)  (9 Samples Mean)  (10 Samples Mean)
46	 Tune	Tuning type selection	 (Disabled) Default  (Automatic) PID parameters are calculated at activation and change of set.  (Manual) Launch from keys or digital input.
47	 Setpoint Deviation Tune	Select the deviation from the command setpoint, for the threshold used by autotuning to calculate the PID parameters	0-5000 digit* (tenths of degree if temperature). Default: 10.

* The display of the decimal point depends on the setting of the parameter  and the parameter .

no.	Display	Parameter description	Entering range
48	 Operating Mode	Select operating mode	 (Controller) Default  (Programmed Cycle)  (2 Thresholds Switch)  (2 Thresholds Switch Impulsive)  (3 Thresholds Switch Impulsive)  (4 Thresholds Switch Impulsive)
49	 Automatic / Manual	Enable automatic/manual selection	 (Disabled) Default  (Enabled)  (Enabled Stored)
50	 Digital Input	Digital input functioning (P48 selection must be  or )	 (Disabled) Default: 0.  (Start/Stop)  (Run n.o.)  (Run n.c.)  (Lock Conversion n.o.)  (Lock Conversion n.c.)  (Tune) Manual  (Automatic Manual impulse)  (Automatic Manual Contact)
51	 Gradient	Increase gradient for soft start or pre-programmed cycle	0 disabled 1-9999 Digit/time* (degrees/hours with display of tenths if temperature) Default: 0.

* The display of the decimal point depends on the setting of parameter 

and parameter .

no.	Display	Parameter description	Entering range
52	Maintenance Time 	Maintenance time for pre-programmed cycle	00.00-24.00 hh.mm Default: 00.00.
53	User Menu Cycle Programmed 	Allows the rise gradient and the maintenance time to be changed from the user menu, in pre-programmed cycle functioning	(Disabled) Default (Gradient) (Maintenance Time) (All)
54	Visualization Type 	Select visualization for display 1 and 2	(1 Process, 2 Setpoint) Default (1 Process, 2 Hide after 3 sec.) (1 Setpoint, 2 Process) (1 Setpoint, 2 Hide after 3 sec.)
55	Degree 	Select degree type	: Centigrade Default : Fahrenheit
56	Baud Rate 	Select baud rate for serial communication	 Default
57	Slave Address 	Select slave address for serial communication	1 – 254 Default: 254.
58	Serial Delay 	Select serial delay	0 – 100 milliseconds Default: 20.

no.	Display	Parameter description	Entering range
59	<div style="border: 1px solid black; padding: 2px; display: inline-block;">Maste.</div> Master	Select the master mode	<div style="border: 1px solid black; padding: 2px; display: inline-block;">dis.</div> (Disable) Default <div style="border: 1px solid black; padding: 2px; display: inline-block;">UPro.</div> (Write Process) <div style="border: 1px solid black; padding: 2px; display: inline-block;">rUco.</div> (Read/Write Command Setpoint) <div style="border: 1px solid black; padding: 2px; display: inline-block;">UouP.</div> (Write Output Percentage) <div style="border: 1px solid black; padding: 2px; display: inline-block;">rUAR1</div> (Read/Write Alarm 1 Setpoint) <div style="border: 1px solid black; padding: 2px; display: inline-block;">rPro.</div> (Read Process)
60	<div style="border: 1px solid black; padding: 2px; display: inline-block;">Addr.</div> Address Retransmission	Select address for retransmission	0x0000 – 0xFFFF (hexadecimal) Default: 0x03E9.
61	<div style="border: 1px solid black; padding: 2px; display: inline-block;">Lolr.</div> Lower Limit Retransmission	Lower limit retransmission range	-999 – 9999 digit* (degrees if temperature) Default: 0.
62	<div style="border: 1px solid black; padding: 2px; display: inline-block;">uPlr.</div> Upper Limit Retransmission	Upper limit retransmission range	-999 – 9999 digit* (degrees if temperature) Default: 0.

* The display of the decimal point depends on the setting of parameter

SEn.

 and parameter

dP.

.

12 Alarm Intervention Modes

Absolute Alarm or Threshold Alarm ($\boxed{A AL}$ selection)

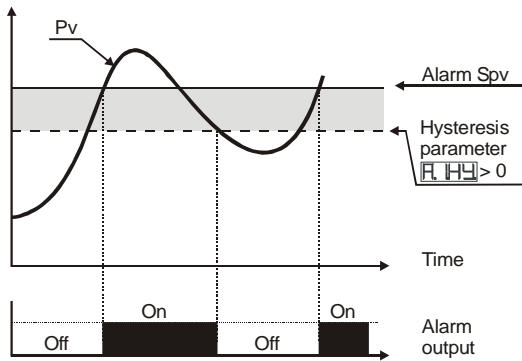

Absolute alarm with controller in heating functioning (Par.11 \boxed{ACEE} selected \boxed{HEAT}) and hysteresis value greater than "0" (Par.28 $\boxed{A HY} > 0$).

N.B.: The example refers to alarm 1; the function can also be enabled for alarms 2 and 3 on models that include it.

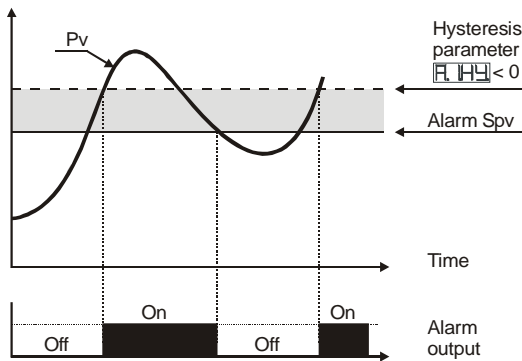

Absolute alarm with controller in heating functioning (Par.11 \boxed{ACEE} selected \boxed{HEAT}) and hysteresis value less than "0" (Par.28 $\boxed{A HY} < 0$).

N.B.: The example refers to alarm 1; the function can also be enabled for alarms 2 and 3 on models that include it.

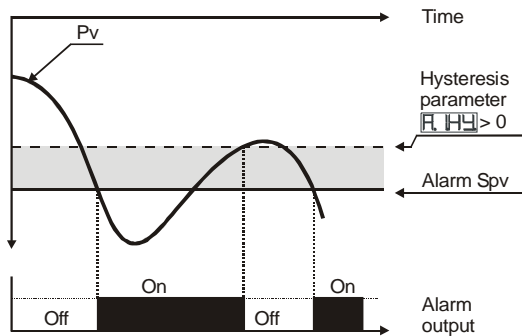

Absolute alarm with controller in cooling functioning (Par.11 \boxed{ACEE} selected \boxed{COOL}) and hysteresis value greater than "0" (Par.28 $\boxed{A HY} > 0$).

N.B.: The example refers to alarm 1; the function can also be enabled for alarms 2 and 3 on models that include it.

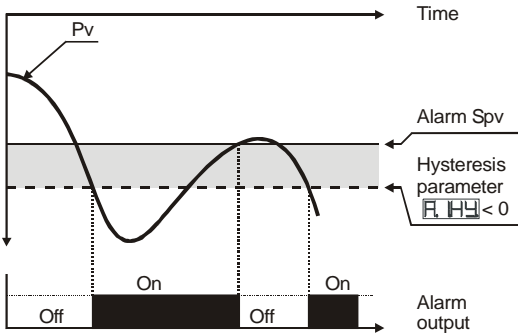

Absolute alarm with controller in cooling functioning (Par.11 **R.CEL** selected **COOL**) and hysteresis value less than "0" (Par.28 **R.HY** < 0).

N.B.: The example refers to alarm 1; the function can also be enabled for alarms 2 and 3 on models that include it.

Absolute Alarm or Threshold Alarm Referring to Setpoint Command (**R.CAL** selection)

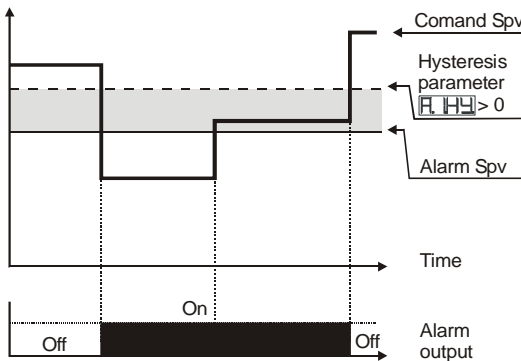

Absolute alarm refers to the command set, with the controller in heating functioning (Par.11 **R.CEL** selected **HEAT**) and hysteresis value greater than "0" (Par.28 **R.HY** > 0).

The command set can be changed by pressing the arrow keys on front panel or using serial port RS485 commands.

N.B.: The example refers to alarm 1; the function can also be enabled for alarms 2 and 3 on models that include it.

Band Alarm (B.AL selection)

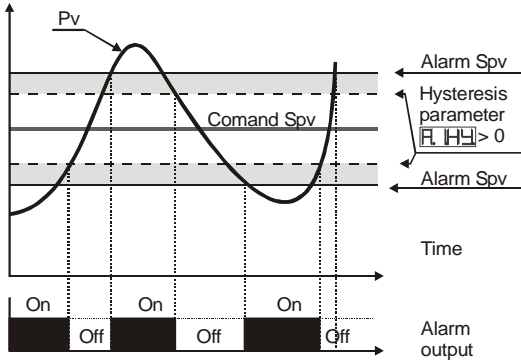

Band alarm hysteresis value greater than "0" (Par.28 $\text{A.IH4} > 0$).

N.B.: The example refers to alarm 1; the function can also be enabled for alarms 2 and 3 on models that include it.

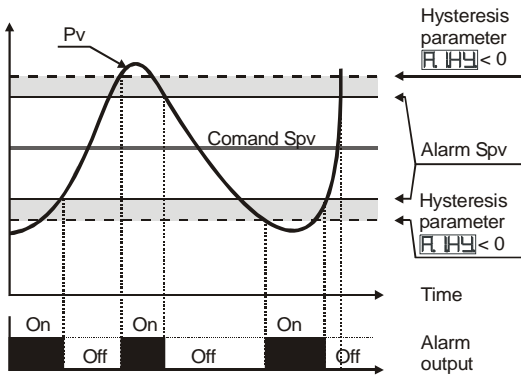

Band alarm hysteresis value less than "0" (Par.28 $\text{A.IH4} < 0$).

N.B.: The example refers to alarm 1; the function can also be enabled for alarms 2 and 3 on models that include it.

Upper Deviation Alarm (HdAL selection)

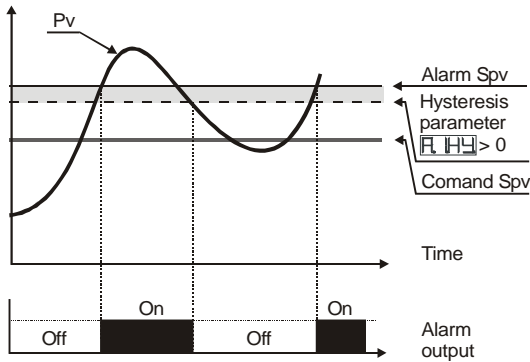

Upper deviation alarm value of alarm setpoint greater than "0" and hysteresis value greater than "0" (Par.28 $\text{R.149} > 0$).

N.B.:

a) The example refers to alarm 1; the function can also be enabled for alarms 2 and 3 on models that include it.

b) With hysteresis less than "0" ($\text{R.149} < 0$) the broken line moves above the alarm setpoint.

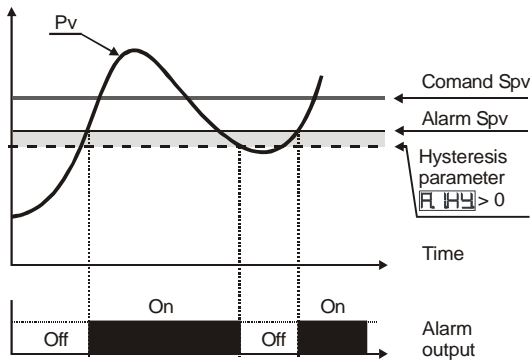

Upper deviation alarm value of alarm setpoint less than "0" and hysteresis value greater than "0" (Par.28 $\text{R.149} > 0$).

N.B.:

a) The example refers to alarm 1; the function can also be enabled for alarms 2 and 3 on models that include it.

b) With hysteresis less than "0" ($\text{R.149} < 0$) the broken line moves above the alarm setpoint.

Lower Deviation Alarm (\overline{HdAL} selection)

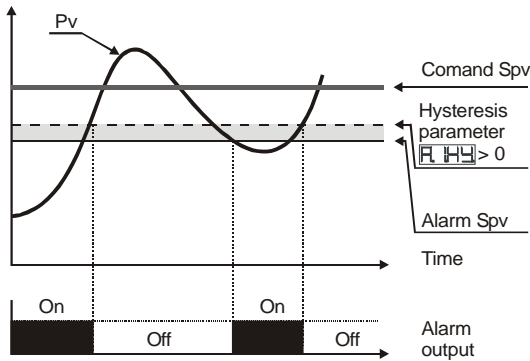

Lower deviation alarm value of alarm setpoint greater than "0" and hysteresis value greater than "0" (Par.28 $\overline{HdAL} > 0$).

N.B.:

a) The example refers to alarm 1; the function can also be enabled for alarms 2 and 3 on models that include it.

b) With hysteresis less than "0" ($\overline{HdAL} < 0$) the broken line moves under the alarm setpoint.

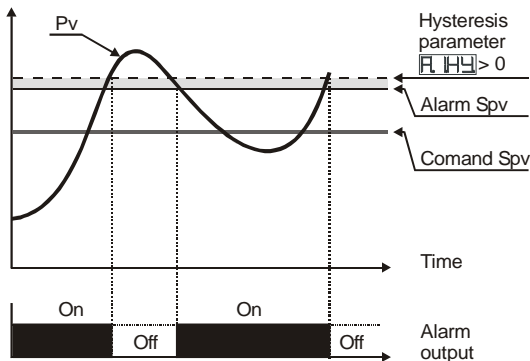

Lower deviation alarm value of alarm setpoint less than "0" and hysteresis value greater than "0" (Par.28 $\overline{HdAL} > 0$).

N.B.:

a) The example refers to alarm 1; the function can also be enabled for alarms 2 and 3 on models that include it

b) With hysteresis value less than "0" ($\overline{HdAL} < 0$) the broken line moves under the alarm setpoint.

13 Table of Anomaly Signals

In case of malfunctioning of the system, the controller switches off the regulation output and displays the type of anomaly.

For example the controller will signal the breakage of any connected thermocouple by displaying **E-05** (flashing) on display. For other notifications, see the table below.

#	Cause	What to do
E-01	Error in E ² PROM cell programming	Call Assistance
E-02	Cold junction sensor fault or room temperature outside of allowed limits.	Call Assistance
E-04	Incorrect configuration data. Possible loss of calibration values.	Check if the configuration parameters are correct.
E-05	Thermocouple open or temperature outside of limits.	Check the connection with the sensors and their integrity.
E-06	Off-line in master mode remote process	Check the serial connection, baud-rate and device ID .

14 Summary of Configuration parameters

Date:	Model ATR142:
Installer:	System:
Notes:	

c.out	Command output type selection	
SEn	Analog input configuration	
dP.	Number of decimal points	
LoLS	Lower limit setpoint	
uPLS	Upper limit setpoint	
LoL.	Lower limit range An1 only for linear	
uPL.	Upper limit range An1 only for linear	
LAtc.	Automatic setting of linear input limits.	
ocAL	Offset calibration	
GcAL	Gain calibration	
Actt.	Regulation type	
c. rE.	Command output reset type	
c. SE.	Contact state for command output in case of error	
c. Ld	Define the OUT1 led state	
c. HY	Hysteresis in ON/OFF or dead band in P.I.D.	
c. dE.	Command delay	
c. SP.	Command setpoint protection	
Pb	Proportional band	
t. i	Integral time	
t. d	Derivative time	
t. c.	Cycle time	
oPoL	Limit of output power %	
AL. 1	Alarm 1 selection	
A. 1Sa	Alarm 1 output contact and intervention type	
A. 1rE.	Reset type of alarm 1 contact.	
A. 1SE.	State of contact for alarm 1 output	

A.Ld	State of OUT2 led	
A.HY	Alarm 1 hysteresis	
A.DE	Alarm1 delay	
A.ISP	Alarm 1 set protection	
AL.2	Alarm 2 selection	
A2.Sa	Alarm 2 output contact and intervention type	
A2-E	Reset type of alarm 2 contact	
A2.SE	State of contact for alarm 2 output	
A2Ld	State of OUT2 led	
A2HY	Alarm 2 hysteresis	
A2dE	Alarm 2 delay	
A2.SP	Alarm 2 set protection	
coaF	Cooling fluid type	
PbN	Proportional band multiplier	
owdb	Overlapping/Dead band	
coctc	Cycle time for cooling output	
cFLE	Analog converter filter	
cFcn	Sampling frequency of analog converter	
wFLE	Display filter	
tunE	Autotuning type selection	
Sdtu	Command setpoint deviation for tuning threshold	
oPNa	Operating mode	
AwNA	Automatic/manual selection	
dGE.1	Digital input functioning	
GrAd	Gradient for soft start	
NAE.1	Cycle maintenance time	
wcP	Gradient change and maintenance time by user	
u.tY	Display data selection	
dEGr	Degree type selection	
bdrE	Select baud rate for serial communication	
SLAd	Select slave address	
SEdE	Select the serial delay	
NASE	Select value to retransmit by ModBus	

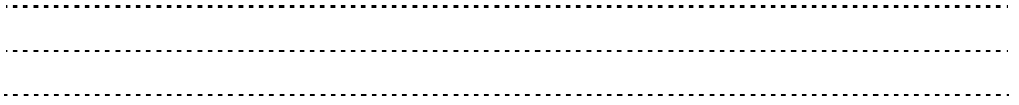

PIXSYS

Via Tagliamento, 18

30030 Mellaredo di Pianiga (VE)

www.pixsys.net

e-mail: sales@pixsys.net - support@pixsys.net

Software Rev. 1.04

2300.10.093-RevC 200608

*** 2300 . 10 . 093 - C ***