

Inductive sensor
With switching distance
BI2-EG08K-AP6X-V1131

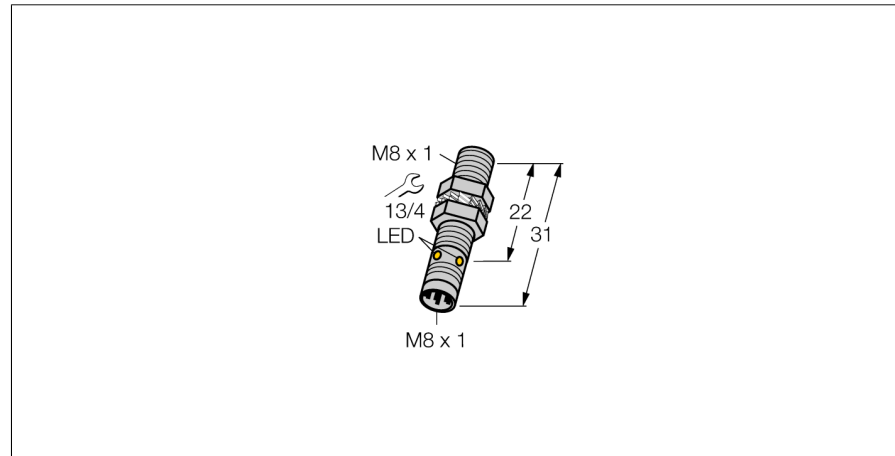

- Threaded barrel, M8 x 1
- Stainless steel, 1.4427 SO
- Large coverage
- DC 3-wire, 10...30 VDC
- NO contact, PNP output
- M8 x 1 male connector

Wiring diagram

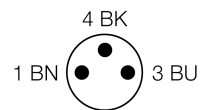
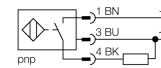

Type code	BI2-EG08K-AP6X-V1131
Ident no.	4669450
Rated operating distance Sn	2 mm
Mounting condition	flush
Assured switching distance	≤ (0,81 x Sn) mm
Repeatability	≤ 2 % of full scale
Temperature drift	≤ ± 10 %
Hysteresis	3...15 %
Ambient temperature	-25...+70 °C
Operating voltage	10...30VDC
Residual ripple	≤ 10 % U _{ss}
DC rated operational current	≤ 150 mA
No-load current I ₀	≤ 15 mA
Residual current	≤ 0.1 mA
Rated insulation voltage	≤ 0.5 kV
Short-circuit protection	yes/ cyclic
Voltage drop at I ₀	≤ 1.8 V
Wire breakage / Reverse polarity protection	yes/ complete
Output function	3-wire, NO contact, PNP
Switching frequency	3 kHz
Construction	threaded barrel, M8 x 1
Dimensions	31 mm
Housing material	stainless steel, 1.4427 SO
Material active area	plastic, PA
Max. tightening torque housing nut	5 Nm
Connection	male, M8 x 1
Vibration resistance	55 Hz (1 mm)
Shock resistance	30 g (11 ms)
IP Rating	IP67
MTTF	2283 years acc. to SN 29500 (Ed. 99) 40 °C
Switching state	LED yellow

Functional principle

Inductive sensors detect metal objects contactless and wear-free. For this, they use a high-frequency electromagnetic AC field that interacts with the target. Inductive sensors generate this field via an RLC circuit with a ferrite coil.

Inductive sensor
With switching distance
BI2-EG08K-AP6X-V1131

Distance D	2 x B
Distance W	3 x Sn
Distance T	3 x B
Distance S	1.5 x B
Distance G	6 x Sn
<hr/>	
Diameter of the active area B	Ø 8 mm



**Inductive sensor
With switching distance
BI2-EG08K-AP6X-V1131**

Accessories

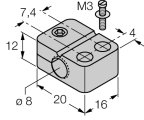
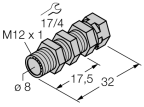
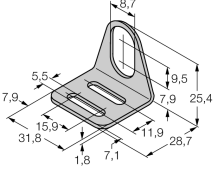
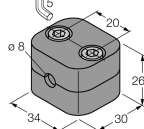
Type code	Ident no.	Description	Design
BST-08B	6947210	Fixing clamp for threaded barrel devices, with dead-stop; material: PA6	
QM-08	6945100	Quick-mount bracket with dead-stop, chrome-plated brass, male thread M12 x 1. Note: The switching distance of proximity switches may be reduced through the use of quick-mount brackets.	
MW-08	6945008	Mounting bracket for threaded barrel devices; material: Stainless steel A2 1.4301 (AISI 304)	
BSS-08	6901322	Mounting bracket for smooth and threaded barrel devices; material: Polypropylene	

Wiring accessories

Type code	Ident no.	Description	Design
PKG3M-2/TEL	6625385	Connection cable, female M8, straight, 3-pin, stainless steel coupling nut, cable length: 2 m, sheath material: PVC, black; cULus approval; other cable lengths and qualities available, see www.turck.com	