

REV.	ECN NO.
00	-----

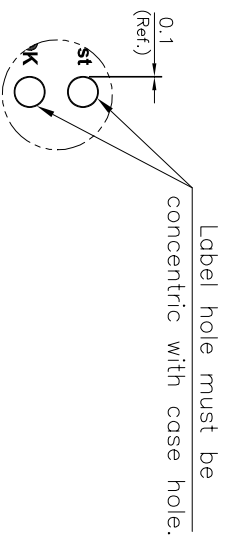

Detail "A"
Scale 2:1

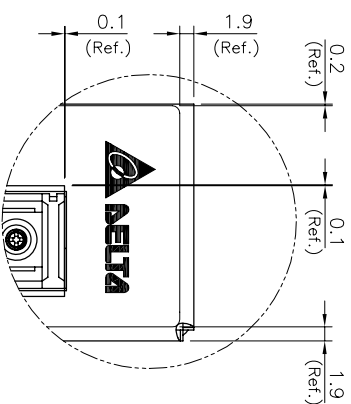
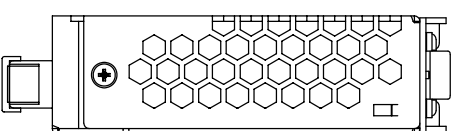

Detail "C"
Scale 2:1

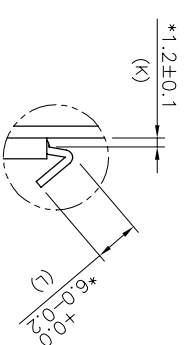

Detail "B"
Scale 2:1

SPRING FORCE
For Latch: 1.0~2.5 Kgf.
For Release: 2.5~4.0 Kgf. (Max Stroke)

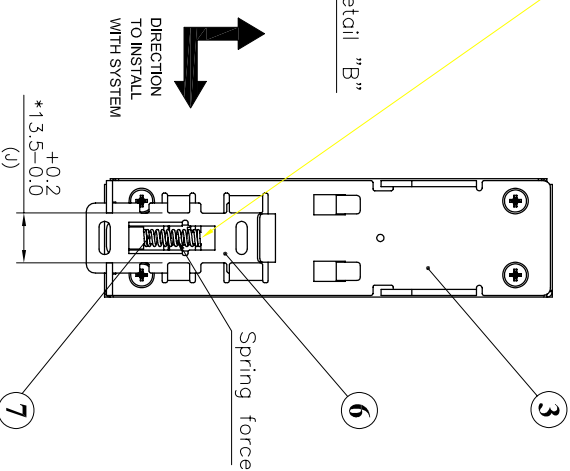
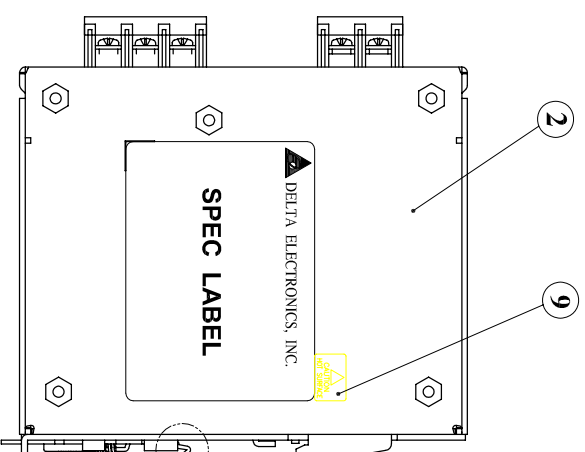
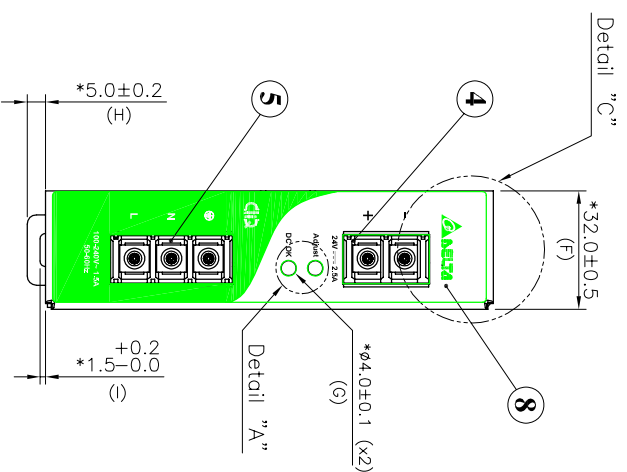
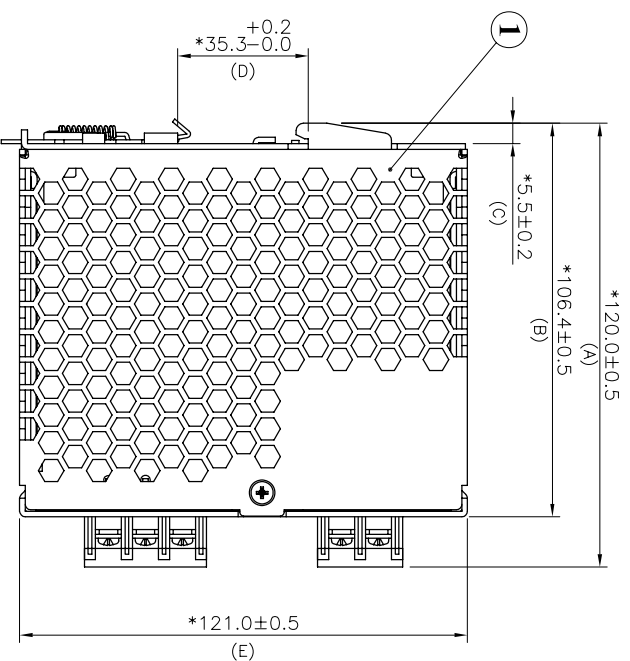

ITEM	DESCRIPTION	DELTA P/N	Q'TY
1	CASE COVER	33106789XX	1
2	CASE CHASSIS	33106791XX	1
3	CASE BACK	33106790XX	1
4	TERMINAL BLOCK 2 PIN	3073044246	1
5	TERMINAL BLOCK 3 PIN	3073044346	1
6	LATCH	34600881XX	1
7	SPRING	34620262XX	1
8	FRONT LABEL	32630346XX	1
9	CAUTION LABEL	32023152XX	1

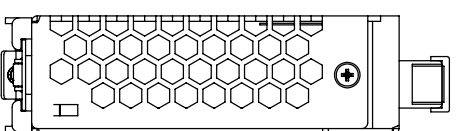

- NOTES:
1. " * " IS CRITICAL DIMENSION MUST BE INSPECTED.
 2. PRODUCT SURFACE SHOULD BE CLEAN.
 3. SPEC LABEL DETAIL AND PRINTING CONTENTS REFER TO SN.
 4. MUST MEET DELTA GENERAL STANDARD: 10000-0162.



THESE DRAWINGS AND SPECIFICATIONS ARE THE PROPERTY OF DELTA ELECTRONICS, INC. AND SHALL NOT BE REPRODUCED OR USED AS THE BASIS FOR THE MANUFACTURE OR SELL OF APPARATUS OR DEVICES WITHOUT PERMISSION.

DRAWING NAME:

PHYSICAL DIMENSION DRAWING

USED ON

DRAWN: DATE: DESIGN: ECN NO.:

DIMENSIONAL TOLERANCES

()	()	()	()	()	ANGLES
DECIMALS <50	±0.1	<50	±0.15	<50	<30° : ±0.1°
X : ±0.3	>50-100 : ±0.15	>50-100 : ±0.2	>100-200 : ±0.25	>100-200 : ±0.25	>30°-60° : ±0.3°
X.X : ±0.2	>100-200 : ±0.2	>100-200 : ±0.2	>100-200 : ±0.25	>100-200 : ±0.25	>60°-90° : ±0.5°
X.XX : ±0.1	>200- : ±0.2%	>200- : ±0.25%	>200- : ±0.25%	>200- : ±0.25%	

PART NO.: DRP024V060W1AA

THIRD ANGLE PROJECTION

SCALE SHEET 1 OF 1

REV. 00