



Automation for a Changing World

Delta CNC Solution

www.delta.com.tw/ia

 **DELTA**
Smarter. Greener. Together.



Delta CNC Solution: an integrated system that provides flexibility and completeness, and fulfills all the significant requirements of the machining industry.

Delta Electronics Inc., a leading professional manufacturer of industrial automation products, is pleased to announce the launch of the innovative CNC Solution that offers an outstanding integrated system for the CNC machine tools industry.

The CNC machine tools industry in Taiwan and the rest of the world has relied heavily on European and Japanese brands which usually offer less flexibility, high maintenance costs and additional expenses for more functions, hardware, and software. As a result, for Taiwan's machine tool manufacturers costly and time consuming "Mix-and-Match components" have been the default option to satisfy their customers' needs.

The Delta CNC Solution is the first complete total solution developed and made by a Taiwanese company to assist customers in the CNC machine tool fields that are facing an advanced phase of global market competition.

Key to Success - The Delta CNC Solution includes CNC controllers, multi-axis servo drives and up to 20-bit high resolution servo motors, and permanent magnet (PM) spindle drives and motors that provide an embedded system with multiple CPUs to distribute multitasking and raise the operating performance of controllers. Combined with the Delta's high speed motion control system DMCNET, the Delta CNC Solution delivers a high speed, high precision system for exceptional performance while helping enterprises succeed in business with enhanced productivity and efficiency.

Win-win - The Delta CNC Solution features high speed, high precision and superior surface finishing to enhance the speed, quality and stability of CNC machine tools. It is suitable for high-speed tapping, engraving and milling processes, tooling machine manufacturing, component processing as well as other manufacturing and related industries. With increasing challenges in the changing global market, the Delta CNC Solution delivers the ultimate in performance to help the machine tools industry excel and stay competitive through continuous innovation and customization.

Table of Contents

Design Concept and Future Development	02	
System Structure	03	
Features	05	
Long Precision Life		
High Machining Precision		
Fast Processing Time		
Easy Design and Installation		
Safe and Energy Saving		
Application Examples	13	
Engraving and Milling Machines		
Gantry Milling Machines		
Machining Centers		
High Speed Tapping Machines		
Software Tools	17	
List of Products	19	
Specifications	21	
Dimensions	30	
Optional Accessories	33	

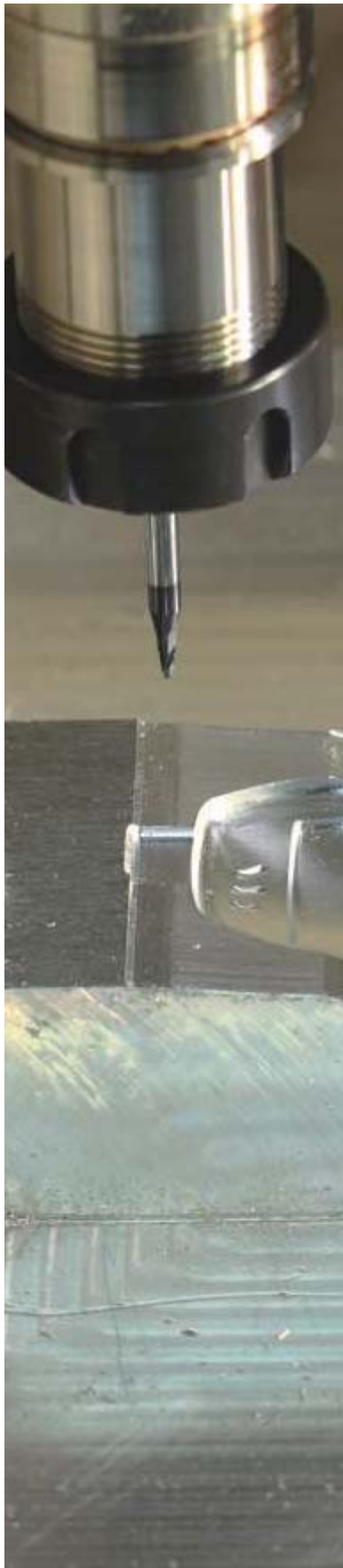

High Performance

Ethernet

CNC Controller NC300 Series



DMCNET™
Delta Motion Control Network

**High Speed
Communication
Protocol**

Optional Accessories



Operation Panels

Optional Accessories



**I/O Boards
(Max. 256 Inputs, Max. 256 Outputs)**

Optional Accessories



Manual Pulse Generator (MPG)



DAC

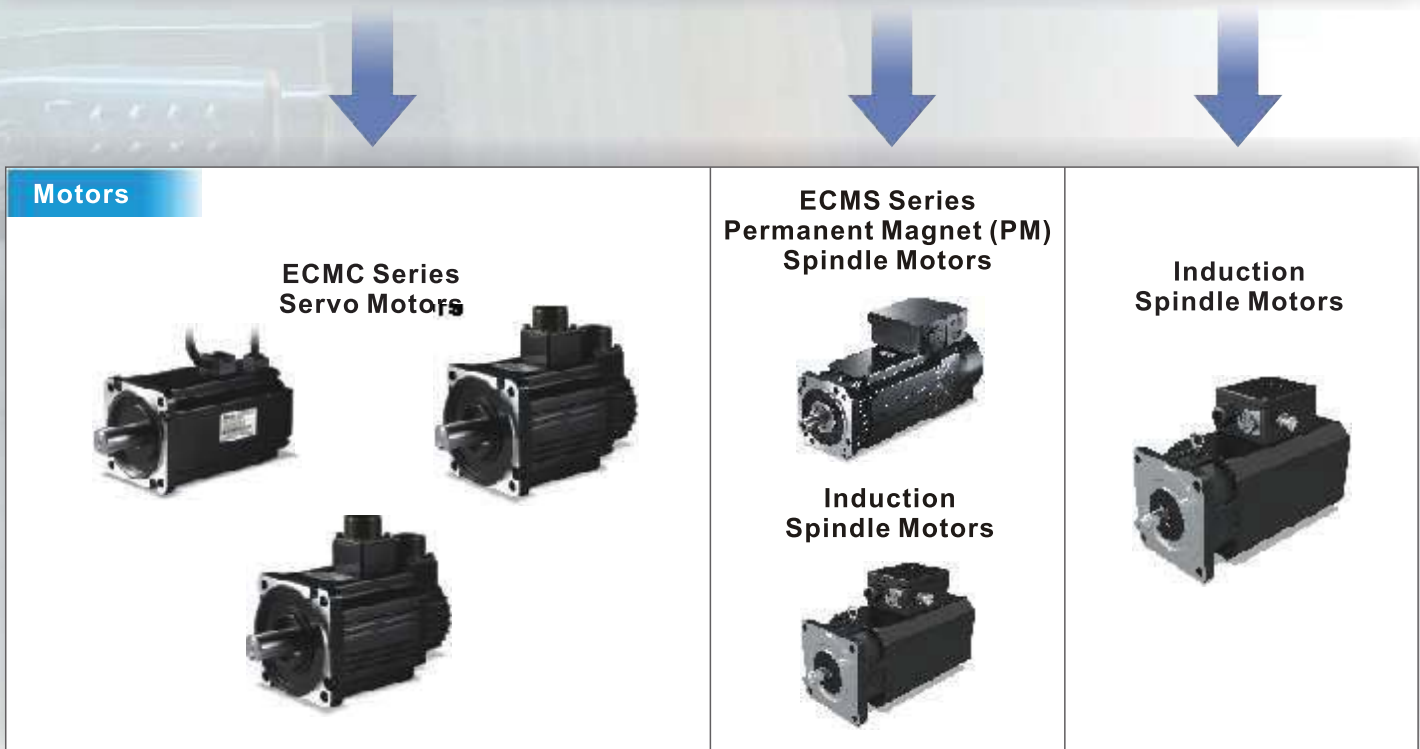
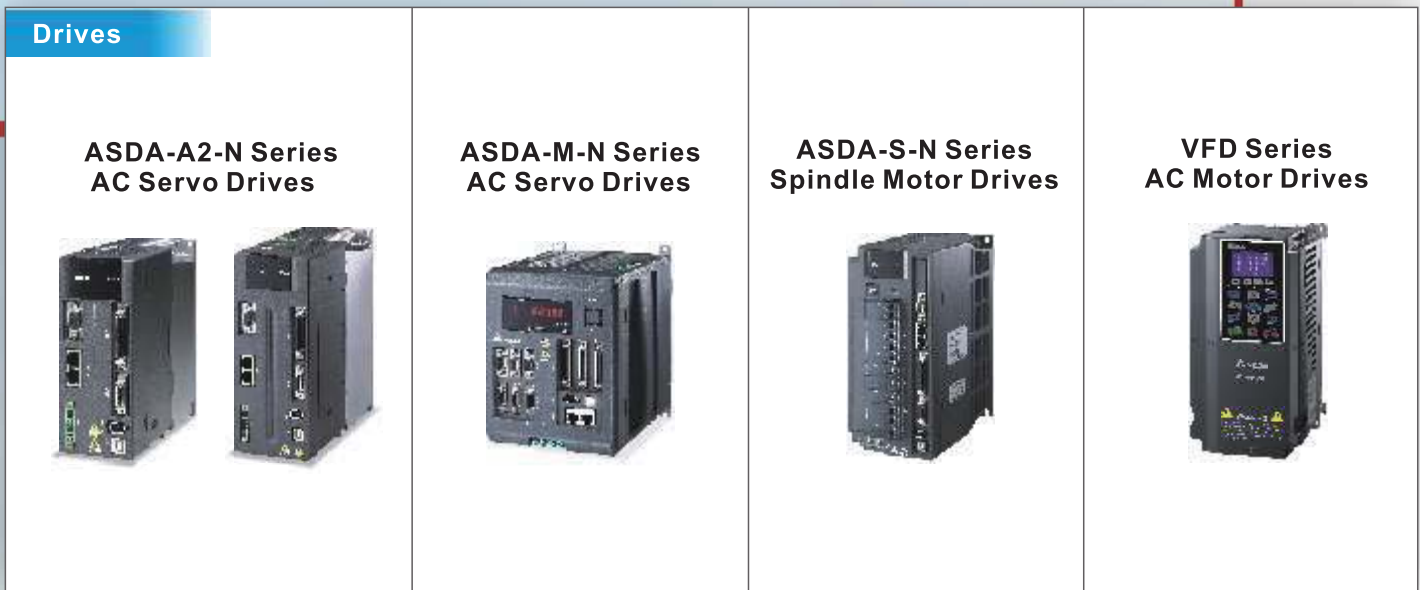

Features - Long Precision Life

Jerk Control

- When acceleration changes significantly, such as where the cutting path changes from a straight line to curve, machine vibration or shock may occur. The Jerk control function is used to control speed and a change of acceleration to suppress vibration and shock and maintain stability and precision for long term operation.

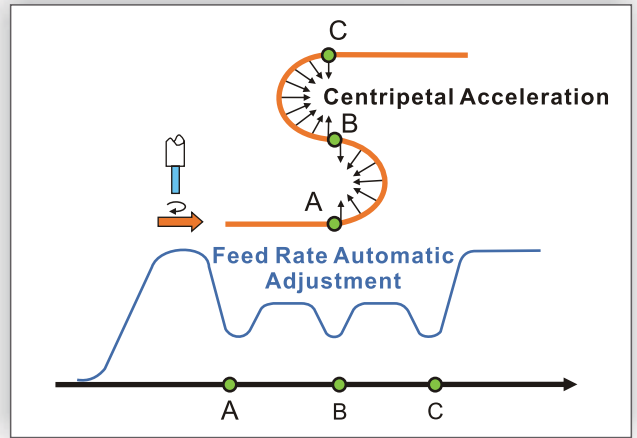

S-Curve Smoothing

- An S-curve acceleration profile for smooth acceleration and deceleration before interpolation minimizes vibration errors and offers a stable and high precision machining process.

Smooth Operation

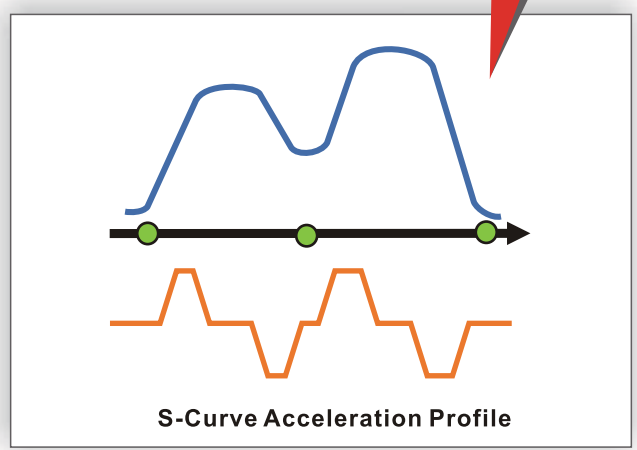
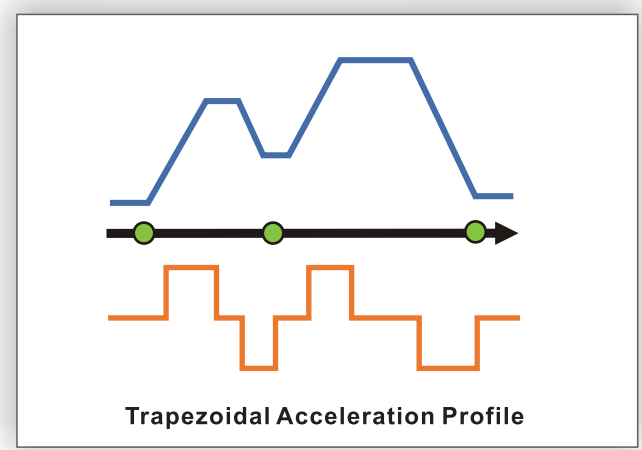

Features - High Machining Precision

Fine Interpolation Commands

- Delta's AC servo drives execute a high sampling interpolation function which smooths the internal drive commands and controls the operation of servo motors with more precision and stability. The processing surface can be finely finished to meet the most demanding customer requirements.

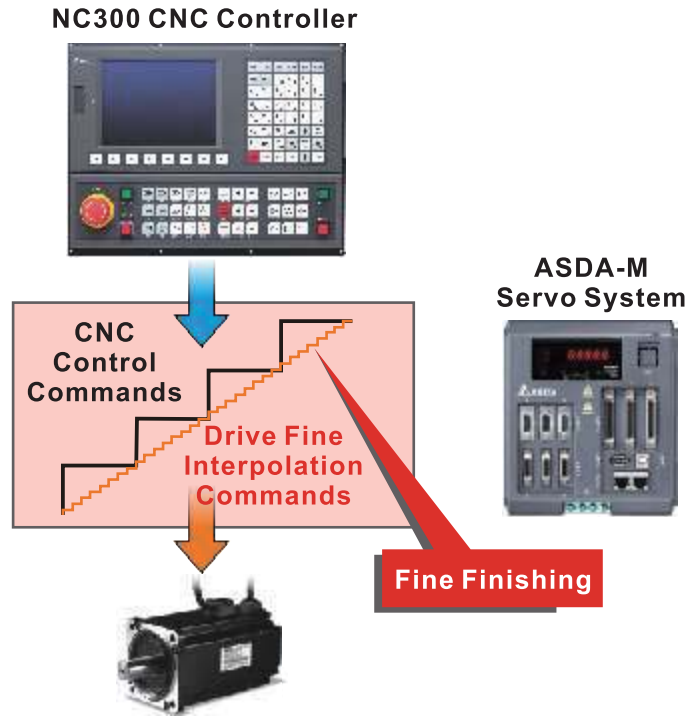

High Speed Motion Control System DMCNET

- With the aid of the DMCNET high speed motion control system, system communication is easy and fast. Wiring is simplified and commands can be delivered with no time delay. There is no high speed pulse command loss problem.

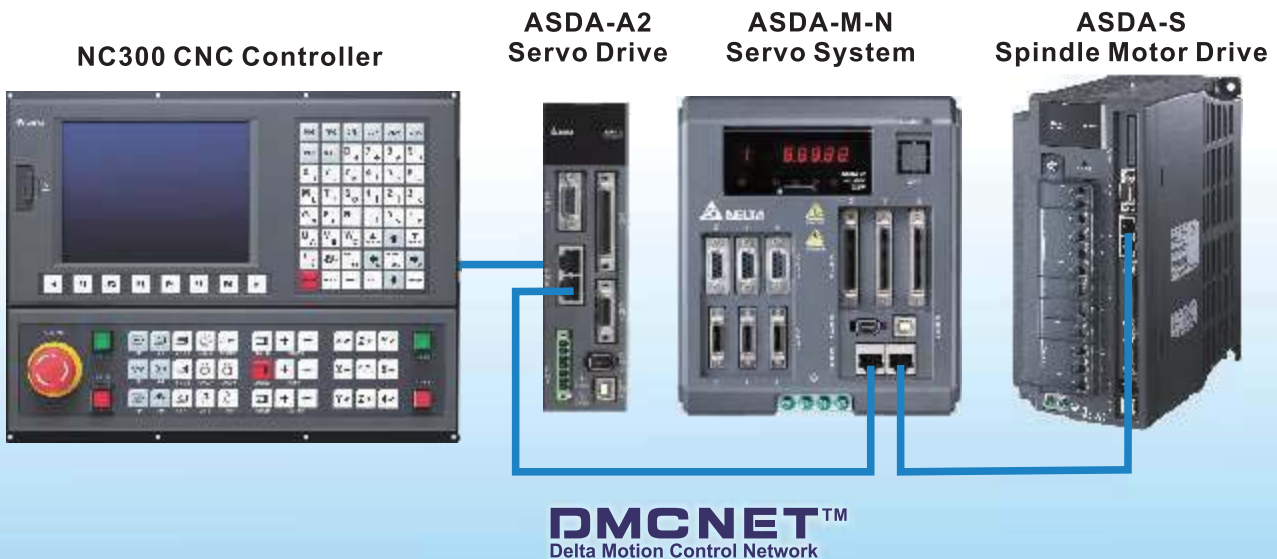

Delta's new DMCNET motion control system is a high speed and real time communication system that offers excellent performance and safety with easy installation, high stability and flexible extension.

Features - High Machining Precision

Automatic Corner Deceleration

- During machining processes, corner deceleration can be automatically calculated to help each axis maintain its precision and speed at corners and effectively smooth the process.

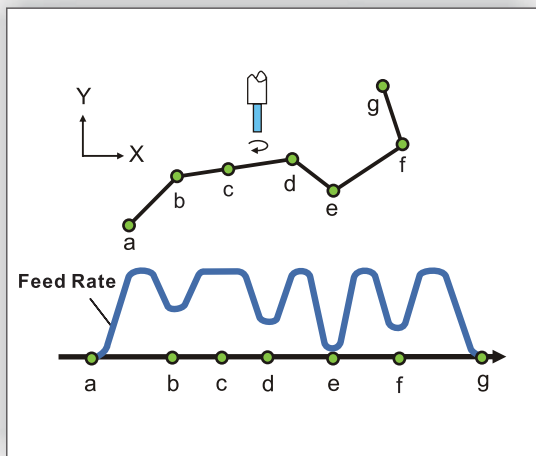

Friction Compensation

- The servo drives can provide real-time and smooth friction compensation with high sampling speed control loop for correcting the torque.

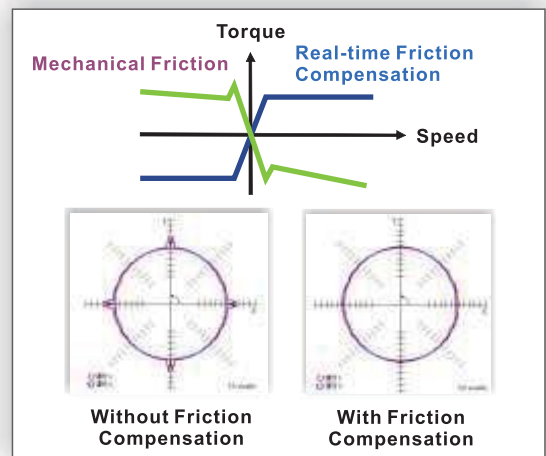

Three-in-One Servo Drive with Synchronous Control

Advanced Gantry Control

- A large amount of data and calculations among 3 axes can be completed with the same DSP (Digital Signal Processor). Precise synchronization is easy to achieve. This greatly increases the efficiency and performance of gantry control.
- In rigid or general mechanical systems, no matter if the loading on multiple axes is equal or not, the ASDA-M-N series servo system can perform precise motion control and drive each axis simultaneously.

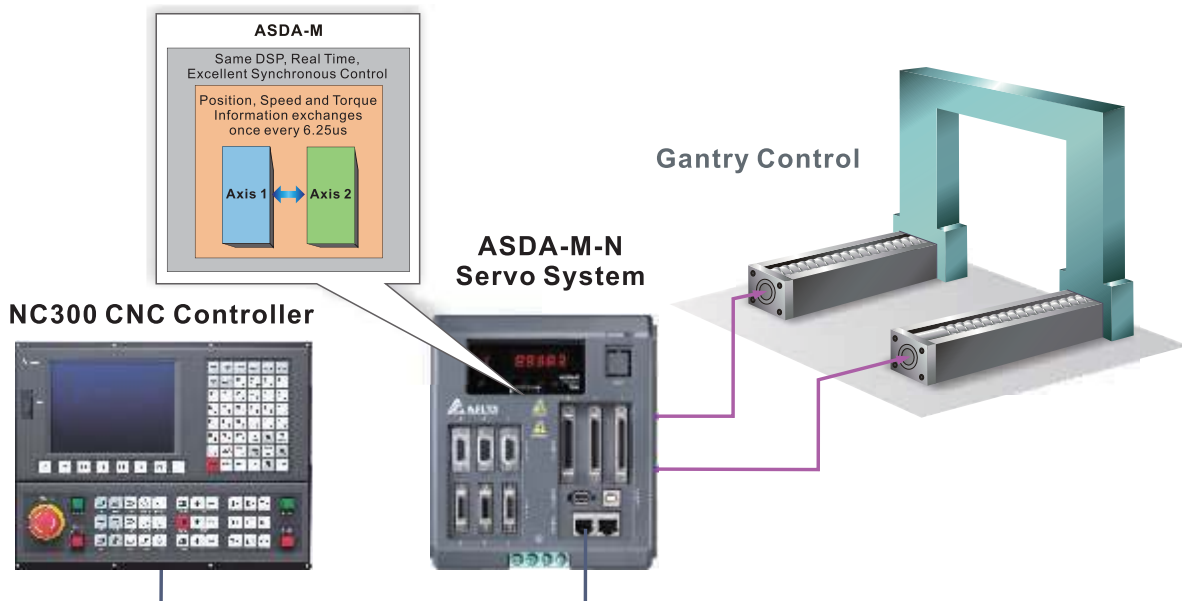

Features - High Machining Precision

High Precision Full-closed Loop Control

- The servo drives can feed back signals from the main encoders and linear scales to perform real-time compensation. This reduces the effect of backlash and flexibility from the machine and ensures the accuracy of positioning.

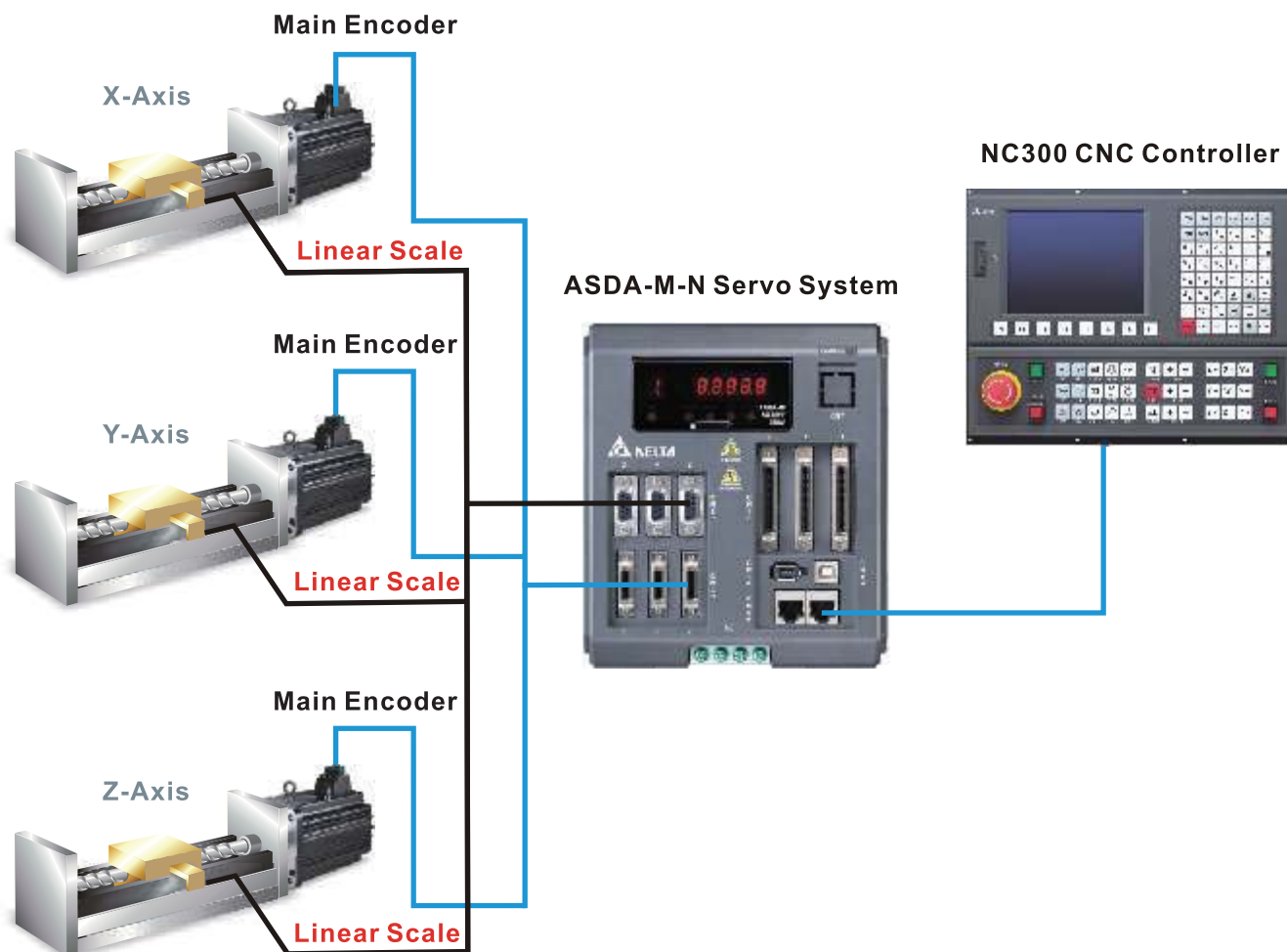

High Resolution Feed Axis Servo Motors

- Delta's ECMC series servo motors are equipped with a 20-bit high resolution encoder (1280000 p/rev) to enhance positioning precision and stability during lower speed operation.

Encoder Resolution: 1280000 p/rev



Features - Fast Processing Time

High Speed Permanent Magnet (PM) Spindle Motors

- Delta's ECMS series servo spindle motors are designed for CNC tapping machinery and provide excellent acceleration performance. The rated speed is 6000r/min. The speed for rigid tapping operations can reach a maximum of 12000r/min. Acceleration goes from 0r/min to 6000r/min in just 250ms which significantly shortens the processing time.

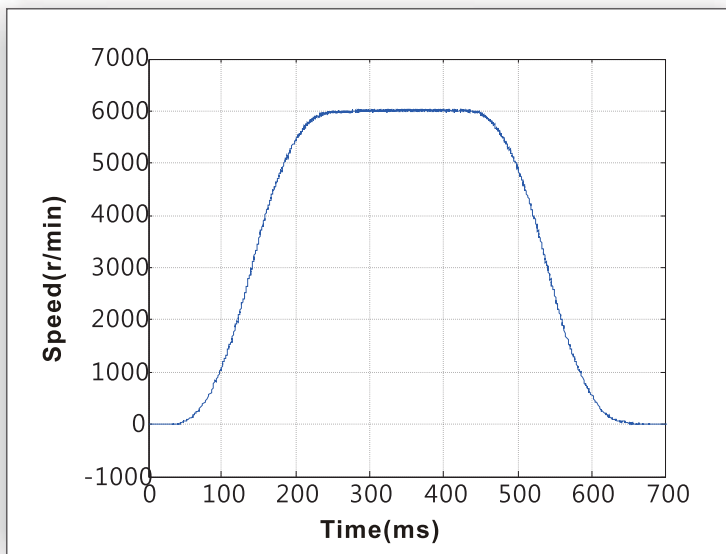

ECMS Spindle Motor

Automatic Tool Length Measurement

- Supports G31 command skip function that can measure tool length with sensors automatically. With program editing, use the G31 command to move the Z-Axis lower and stop the motion when it reaches the sensor on the machine. The moving distance can be recorded and calculated as the compensation value for the tool length. The G31 command can also stop the motion path immediately and simultaneously execute the motion for the next block.

```
G90 G00 Z0.
G01 G31 Z-80.0 F200.
G91 Z10. F400.
G31 Z-10. F50.
```

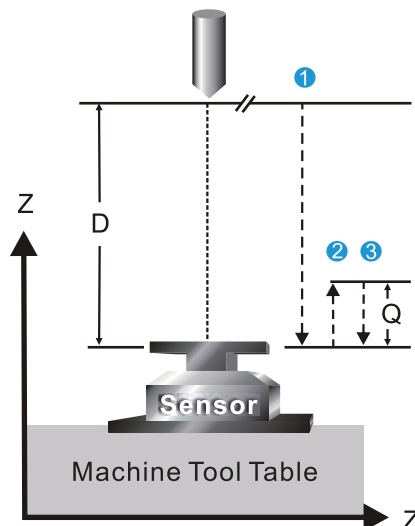

- Reaches sensor with medium or low speed of 200 feed rate
- Pulls up Distance Q with speed of 400 feed rate
- Slowly reaches sensor with speed of 50 feed rate
- Updates measured deviation value to tool table

Features - Fast Processing Time

High Speed Multi-Block Look-Ahead

- High speed multi-block look-ahead function helps users perform processing operation according to the preset feed rate and path. This can efficiently reduce processing time and effectively increase production speed.

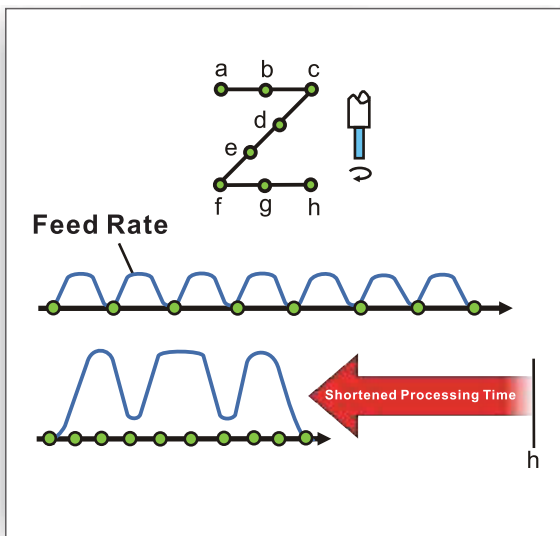

Curve Fitting

- With the curve fitting function, the motion of the processing axis can be smoothed to avoid a turn speed that is not continuous. The precision and speed of the processing operation is enhanced and the processing can be evenly applied as well.

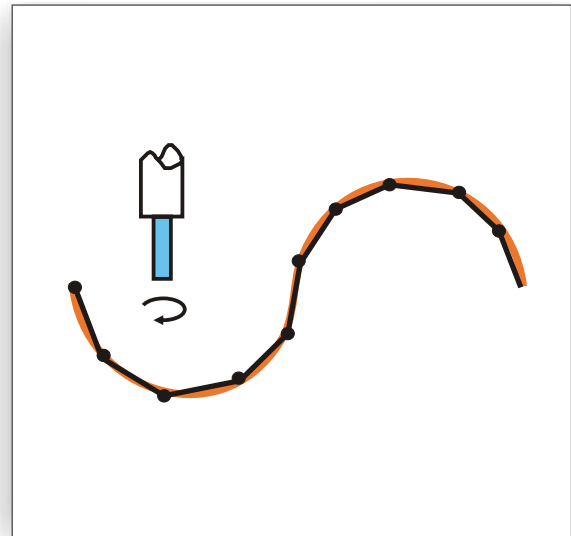

Breakpoint Search

- Through an internal program with breakpoint line number information, users can search breakpoint line numbers and labeled blocks from previous program executions. The program can restart its normal execution from the desired breakpoint. This greatly shortens the time for repetitive program execution and applies to searching for large files.

G-CODE Program

- Displays Content of Executing Program

```

PROGRAM(Search)      03333.NC      SFT
O3333
G40C80
N4G54G98G0X0Y0
N6Z3.000
N7F2000
N8G1X50.294Y-37.881
N9X50.501Y-38.036Z2.966
N10X50.694Y-38.181Z2.866
N11X50.859Y-38.306Z2.707
N12X50.986Y-38.402Z2.500
MECH      ABS      M00 G00 G17 G98 G23 G94 G21
X 5.942 X -4354.680 G40 G49 G80 G98 G50 G64 G69
G15 G54
Break Line Num 1
Search Line Num/Label
        
```

Program Breakpoint Information / Search Setup

- Program Breakpoint Information Display
- Restarts Line Number/Label Number
- Searches Single Block's Line Number / Inputs Specified Label Number

Coordinate Information / Feed Axis Information

- Mechanical Coordinate Information
- Absolute Coordinate Information
- Cutting Feed / Spindle Speed / Tool Number

Search Function

- Executes Search Function

Features - Easy Design and Installation

Workpiece Coordinate / Tool Length Automatic Setup

- Users no longer need to manually input mechanical coordinate values. They can simply use various input functions and G54 commands or other workpiece coordinates for setup. This user-friendly design applies to setting up tool length for more convenience.

Workpiece Coordinate System - Automatic Setup

- Clears specified workpiece coordinate data
- Single axis automatic setup (L input)
- Single axis distance / 2 automatic setups (L/2 input)
- Multi-axes setup (P input)

Num	Length	Radius	Len wear	Rad wear
1	0.000	0.000	0.000	0.000
2	0.000	0.000	0.000	0.000
3	0.000	0.000	0.000	0.000
4	0.000	0.000	0.000	0.000
5	0.000	0.000	0.000	0.000
6	0.000	0.000	0.000	0.000
7	0.000	0.000	0.000	0.000
8	0.000	0.000	0.000	0.000
9	0.000	0.000	0.000	0.000
10	0.000	0.000	0.000	0.000
11	0.000	0.000	0.000	0.000
12	0.000	0.000	0.000	0.000
13	0.000	0.000	0.000	0.000
14	0.000	0.000	0.000	0.000
15	0.000	0.000	0.000	0.000

Tool Registration - H Setup

- Tool length automatic setup (H setup)

Direct Program Execution and Data Storage on USB Disk

- A USB interface is equipped as standard. High-speed data transfer and large program processing are executed instantly. This feature smartly integrates motion, Motion Logic Control (MLC) software, and CNC controller for excellent operation while maintaining high efficiency. (AUTO mode)

NC300 CNC Controller



MECH	ABS	RESIDUAL	G54
X	5.942	X -4354.680	X 0.000
Y	0.000	Y 177.027	Y 0.000
Z	0.000	Z 15.470	Z 0.000
A	0.000	A 0.000	A 0.000

Features - Easy Design and Installation

Software Panel

- When a second operation panel is connected to a CNC controller, its operation can be built via PC software and its functions can be performed via MLC programming. Users can design various shortcut icons for different operations to fulfill the machining requirements of different applications.



Shortcut Icons for Each Key:

- Each shortcut icon on the software panel can correspond to the real keys on the second panel. Users can arrange layout based on their needs. The shortcut icons have the same functions with the real keys on the second panel, which offers more flexible arrangements.
- Cutting feed, high-speed feed, spindle speed, JOG speed, MPG magnification all can be displayed on the software panel.

System Status Information

- Current system mode display
- ALARM messages display
- Magnification status display: Cutting feed, high-speed feed, spindle speed, JOG speed, MPG magnification
- Current system time

Function Keys:

- Relative component index display
- Moves cursor up and down for switching the function display

MLC Online Editing and Monitoring

- Supports MLC online editing and monitoring to display the changes of I/O points for improved process development and debugging maintenance.

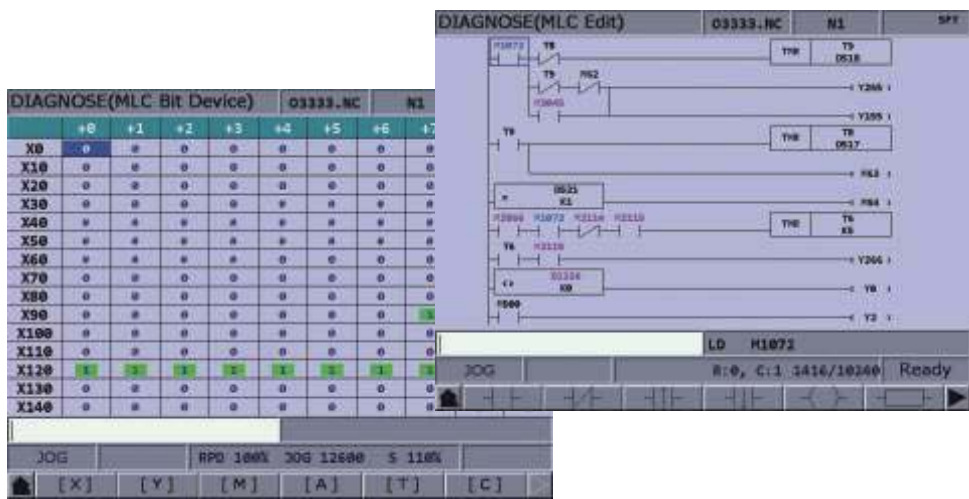

Features - Easy Design and Installation

Data Synchronous Management

- The connection between a PC and an NC can be built through an Ethernet communication network. Users can access and manage files in a NC from a PC. The disk space on a PC can be accessed, stored and utilized in a NC as well. This enhances efficiency of data management and backup.

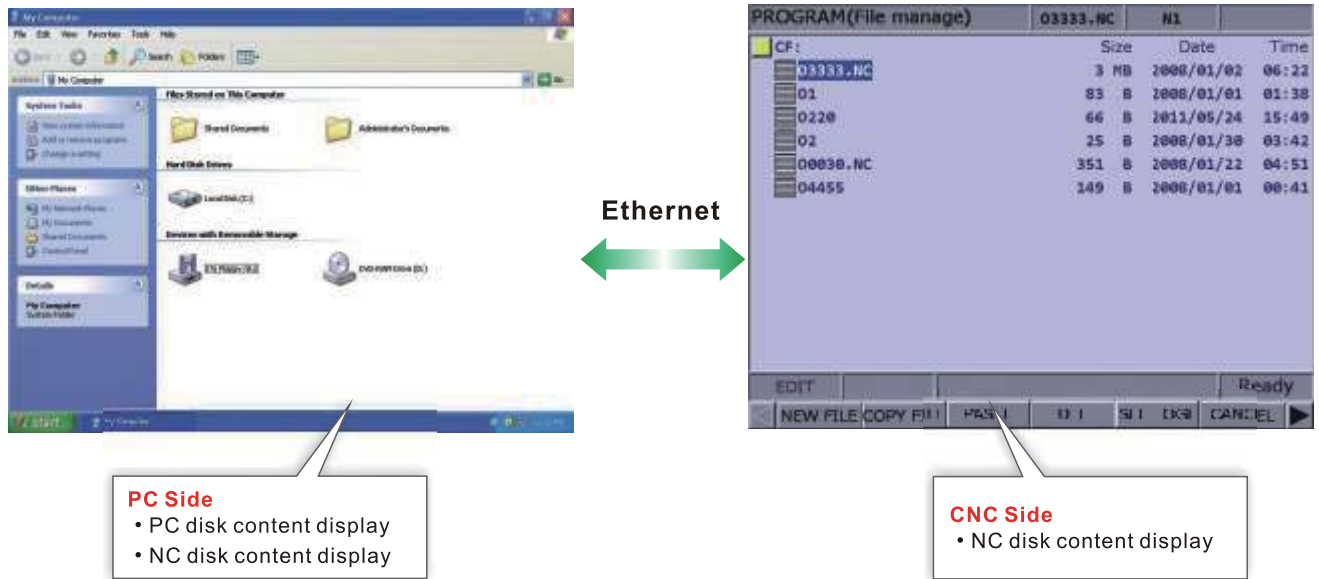

Tool Management Function

- The tool management function allows users to set the tool numbers, reset tool indexes, and lock the desired tools. Setting numbers of the required cutters can prevent repeated use and avoid selecting the incorrect tool. The built-in carousel and armless modules increase the speed of tool function setup.

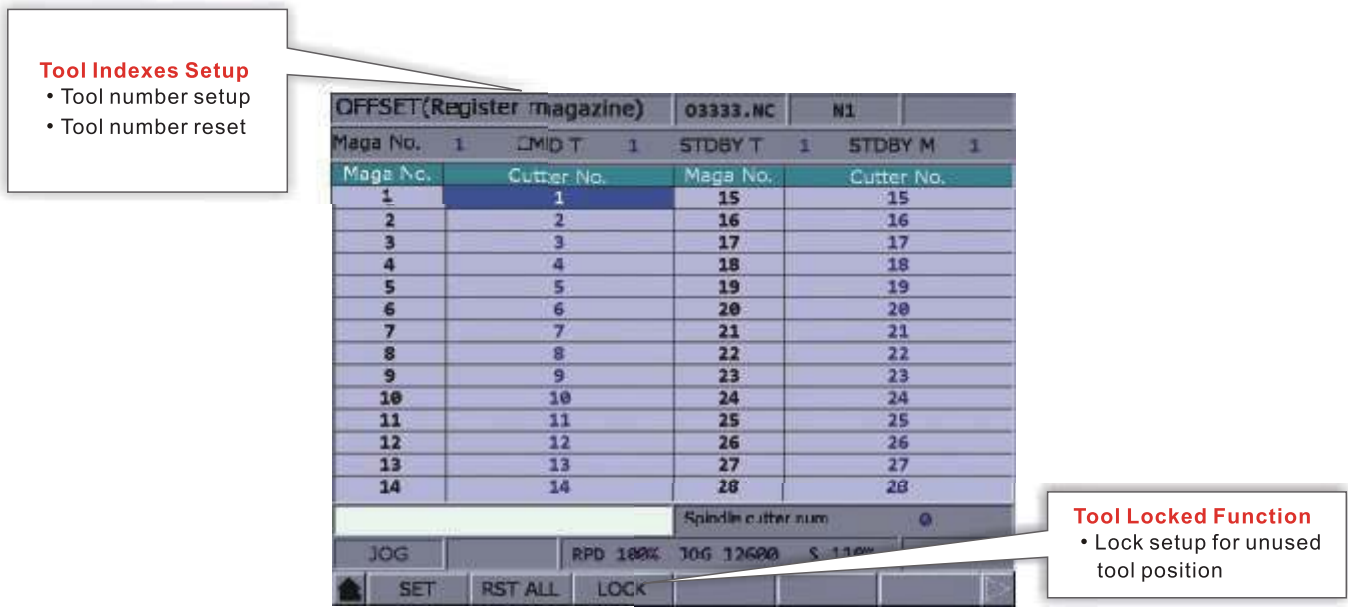

Features - Easy Design and Installation

Servo Parameters Backup and Import

- The NC300 CNC Controller can backup servo parameters for fast import after a servo drive change. This feature makes replacement and maintenance easier and more convenient.

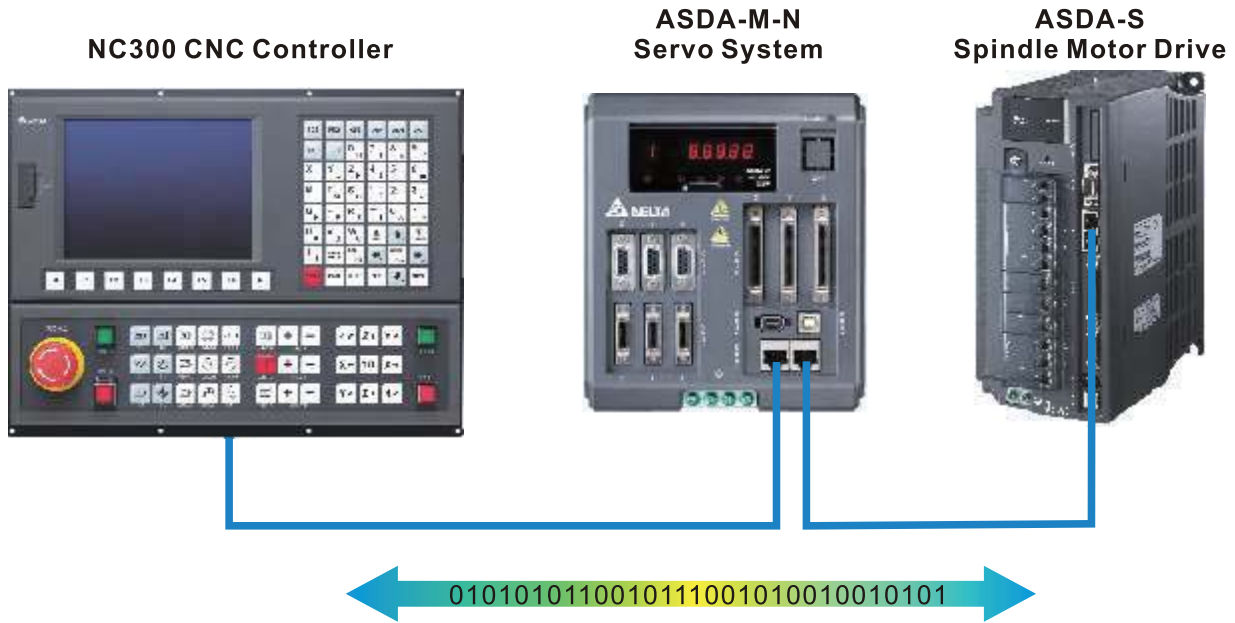

Features

Auto-Gain Tuning for Servo System

- The NC300 CNC controller provides effective gain adjustment during machine tuning, offering the best motion control. Via mechanical inertia and system bandwidth data, the gain parameters can be automatically calculated and downloaded into servo drives for the ultimate system performance.

Servo Drive Status Display

- Servo drive status display
- Servo drive alarm message display

No.	Parameter Name	Calculate	In Drive
P1-17	Load Inertia Ratio	0.0	0.0
P2-00	Position Loop P gain	157	157
P2-02	Position Feedforward	0	0
P2-04	Speed Loop P gain	628	628
P2-06	Speed Loop I gain	300	300
P2-25	USL Reject filter	16	16
P2-26	External Noise Reject	0	0
P2-45	Speed D Filter and J Suppression	[0F]1000	[0F]1000
P2-47	Auto Resonance Suppression Sel	0	0
P2-23	Notch filter Freq(1)	3000	3000
P2-24	Notch filter Gain(1)	0	0
P2-43	Notch filter Freq(2)	3000	3000
P2-44	Notch filter Gain(2)	0	0
P2-46	Notch filter Freq(3)	3000	3000
P2-46	Notch filter Gain(3)	0	0

Motion Control Testing Items

- ‡ Acceleration/Deceleration constant
- ‡ S-curve time constant
- ‡ Sentinel moving speed
- ‡ Job moving speed
- ‡ Time interval

Servo Parameters Display

- Servo parameter content display

Automatic Gain Function Key

- Gain adjustment function index

Test Strobe Set

- Start and end point input

Before/After Gain Parameter Value

- Compares calculated result and parameter value of the servo drive

Features - Safe and Energy Saving

Manual Pulse Generator (MPG) Simulation

- For first time CNC machining, the MPG simulation function is able to perform an exact simulation of the desired machining process under all operating conditions. This guarantees processing stability and eliminates problems with execution error or cutter/tool crashing. The MPG simulation function makes CNC processing safer and more accurate.

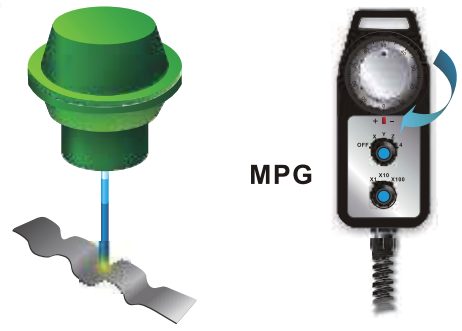

PN Power Sharing for Multiple Axes

ASDA-M-N adopts a design that allows three axes to sufficiently share PN power with output power and regenerated power. This design reduces the input from the grid with effective energy saving.

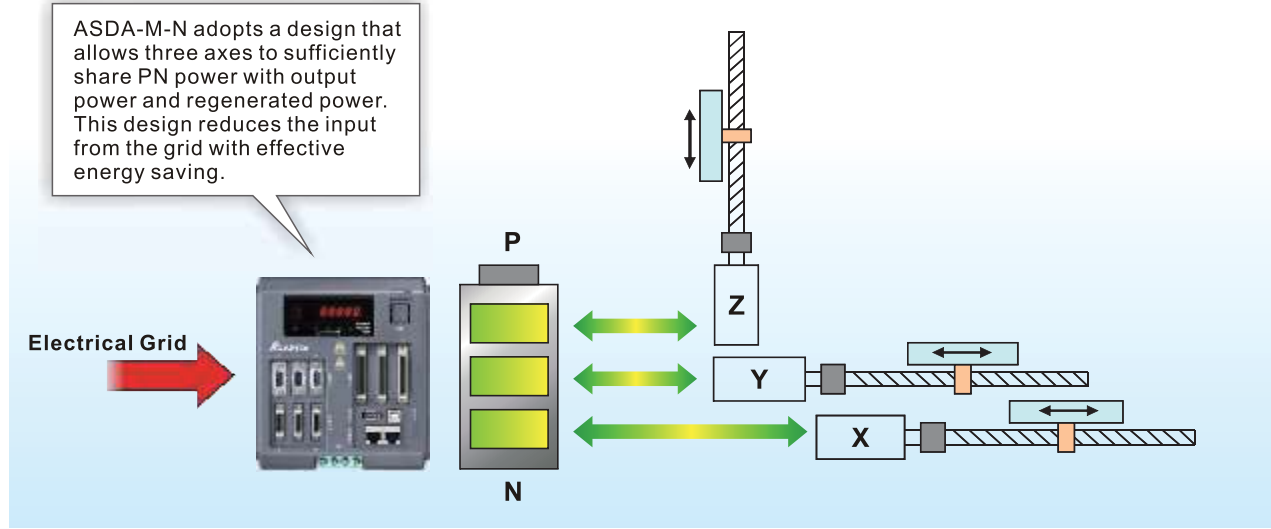

Energy Saving C-Box for Spindle System

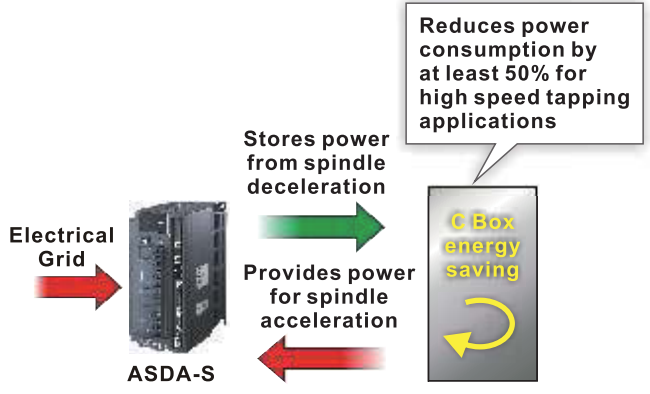

Low Power Consumption Embedded Controller

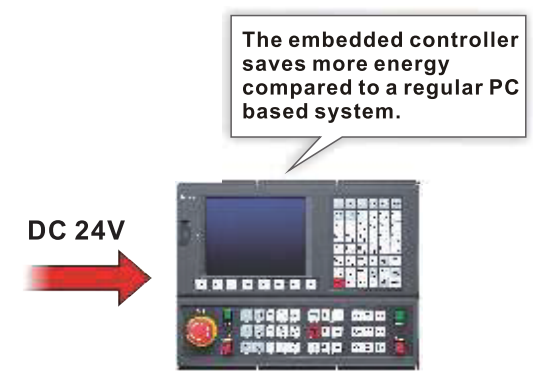

Application Examples

Engraving and Milling Machines

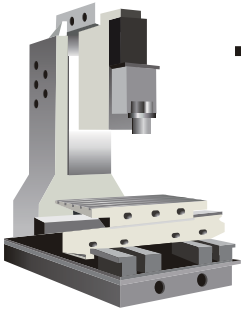

- Delta's all-in-one CNC controller supports practical and user-friendly operation. By integrating with high resolution servo drives and motors, the Delta CNC Solution works effectively for high speed engraving and milling machines for complex geometric contours processing.

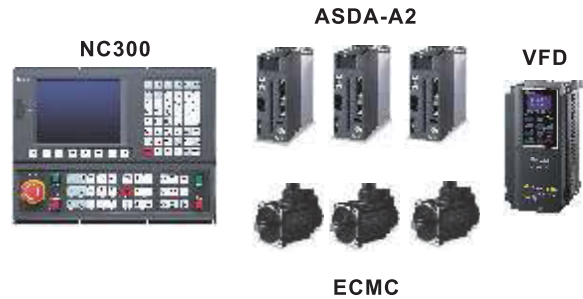

Gantry Milling Machines

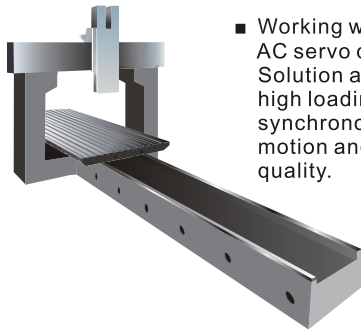

- Working with a three-in-one AC servo drive, the Delta CNC Solution achieves high precision, high loading, multi-axes and synchronous control for a smooth motion and superior machining quality.

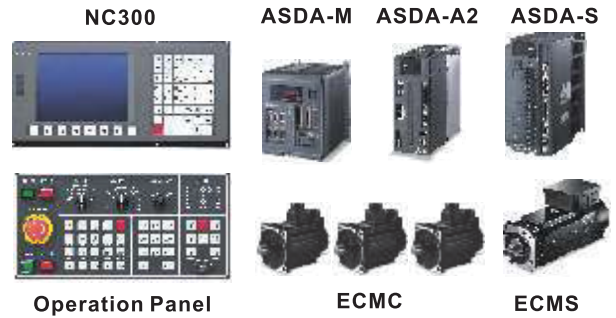

Machining Centers

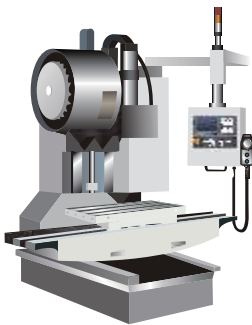

- The Delta CNC Solution offers a numerical control interface with tool editing and management functions that is a perfect fit for various machine centers and composite processing.



High Speed Tapping Machines

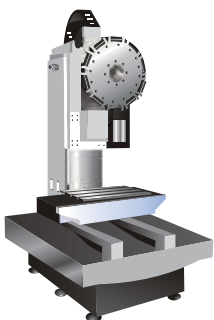

- The vertical CNC controller with PM spindle motors provides a high speed and high precision Delta CNC Solution which effectively applies to high speed tapping machines for the best tapping quality.





Software Tools

MLC Editor

- The MLC editor features a user-friendly interface and complete functions for users to design user-defined programs according to their needs.

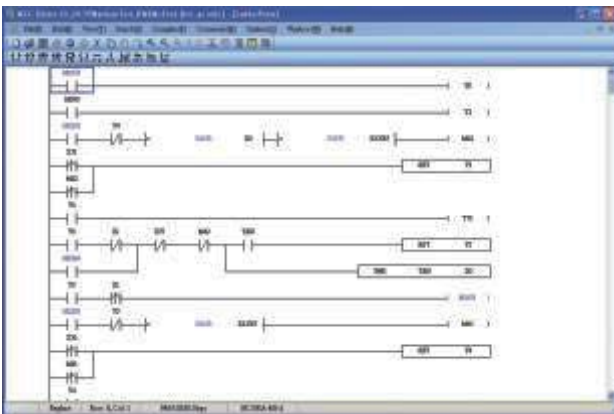

Direct Files Access from PC Side

- The data and files necessary for NC control and machine operation can be directly edited and executed on a personal computer.

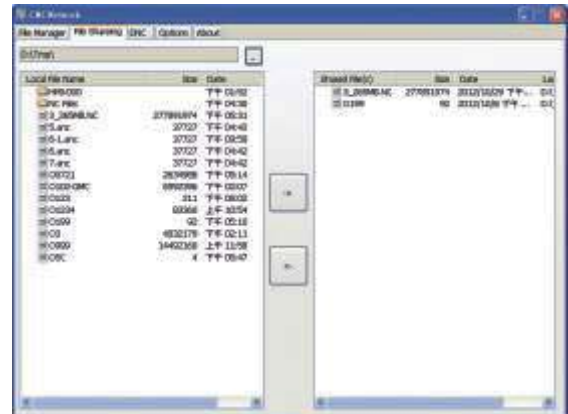

Files and Data Management

- The connection between a PC and an NC is made via simple setup. Users can manage files on a PC and an NC simultaneously. The disk space on a PC can be directly accessed and used from an NC to offer simple, convenient data management and backup support.

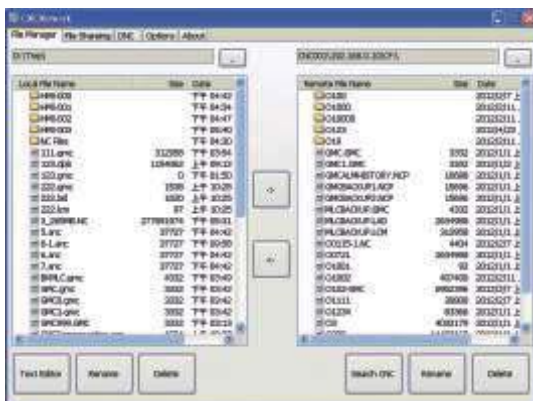

Ethernet





DNC Monitoring

During the file execution from an NC (DNC mode), users can monitor the desired machine operation via the DNC screen.

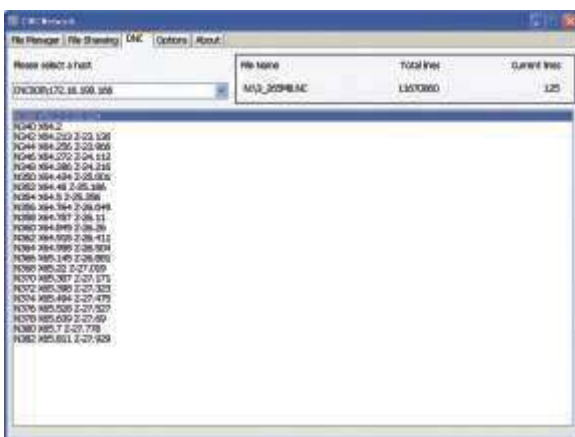

Parameters Editor

Users can easily edit and access parameter information via the convenient parameter editor. After editing, the parameters can be stored back to the NC.

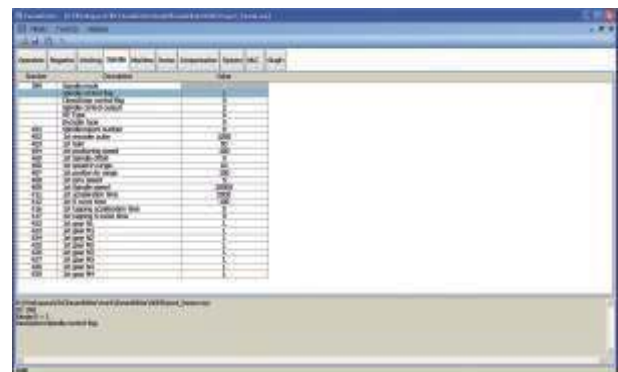

Software Screen Editor

- The software screen editor provides a user-friendly interface and a gallery. Users can self-design and modify the desired functions and screen displays.

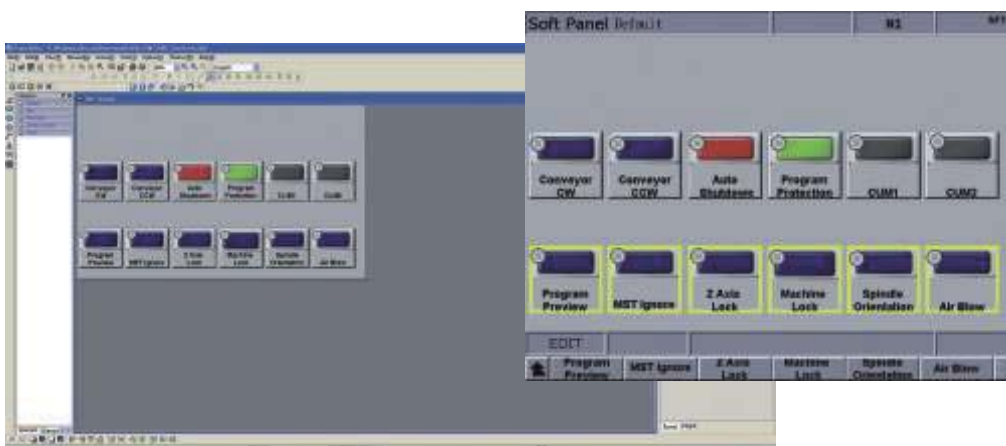

List of Products

High Speed, High Precision CNC Controllers NC300 Series



Product Features:

- Features a built-in 32-bit high speed and high processing dual CPU that can construct a real-time and multi-functional control center
- User-friendly human machine interface offers easy operation and effective monitoring
- Auto-tuning for the servo system so the servo parameters can be set automatically. Optimum control of the mechanical system is easy and in real time
- CNC Soft software offers user-friendly setup support and allows users to build custom screens for user-defined operation
- USB interface for convenient data storage, backup and parameter copies
- Communication type and analog voltage type available for spindles
- MPG function supports pulse input and external manual input
- Serial I/O modules for flexible extension

High Performance Feed Axis Servo Drives ASDA-A2-N Series



Product Features:

- Connecting to the high performance, high resolution 20-bit servo motors ECMC series, up to 1kHz speed response frequency can be reached for high speed and high precision processing applications
- Built-in fine interpolation commands, friction compensation and full-closed loop control functions
- Auto notch filter and resonance suppression minimizes the mechanical vibration and resonance effectively to stabilize the machining operation
- Communicating with the Delta high speed motion control system DMCNET, the CNC Controller can directly perform servo gain adjustment, drive parameters setup and backup

Three-in-one High Performance Feed Axis Servo System ASDA-M-N Series



Product Features:

- Three-in-one design offers multi-axes motion control with only one CPU. This achieves excellent synchronous gantry control and simplifies installation, wiring and setup. PN power sharing of multiple axes is available for energy saving.
- Connecting to high performance, high resolution 20-bit servo motors ECMC series, up to 1kHz speed response frequency can be reached for high speed and high precision processing applications
- Built-in fine interpolation commands, friction compensation and full-closed loop control functions
- Auto notch filter and resonance suppression to minimize the mechanical vibration and resonance effectively and stabilize the machining operation
- Communicating with the Delta high speed motion control system DMCNET, the CNC Controller can directly perform servo gain adjustment, drive parameters setup and backup

Spindle Motor Drives ASDA-S-N Series High Speed PM Spindle Motors ECMS Series



ASDA-S-N Features:

- Supports PM Spindle Motor ECMS Series to offer 6000r/min high speed rigid tapping
- Supports induction spindle motors sold on the market
- Able to connect to Signal Converter Box ASD-IF Series (optional parts) to receive sinusoidal position feedback
- CNC Controller can directly perform automatic gain adjustment, drive parameters setup and backup with the integration of Delta high speed communication motion control network DMCNET and controller
- Reduces electricity consumption with the aid of the energy-saving C-Box for power storage

ECMS Features

- The PM spindle motors ECMS Series are designed for CNC tapping machinery for excellent acceleration performance. Acceleration goes from 0r/min to 6000r/min in just 250ms which significantly shortens the processing time (machine load inertia ratio is less than 1.5)
- Rated speed is 6000r/min, Max. speed is 12000r/min

Specifications - Model Explanation of CNC Controller

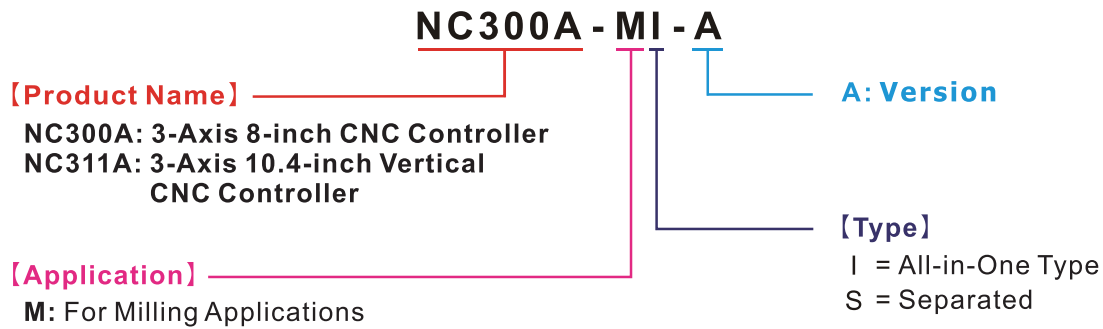

Specifications - CNC Controller Specifications

Control

Controlled Axes	3 Axes (X, Y, Z)
Simultaneous Controlled Axes	Position/Linear interpolation/Circular interpolation (3/3/2)
Least Input Increment	0.001mm / 0.001 deg.
Max. Command Value	±99999.999mm(±9999.9999in)
Acceleration/Deceleration Control	Acceleration/Deceleration before interpolation, S-shaped curve Acceleration/Deceleration
Metric Size	Std.(G21)
Machine Lock	All Axes
Emergency Stop	Standard function
Over-travel	Standard function
DMCNET	Standard function(DMCNET supports up to 6 axes)

Operation

Automatic Operation	Standard function
MDI Operation	Standard function
USB Memory	USB Memory Attachment is Required
Symbol Search	Standard function
Sequence Number Search	Standard function
Dry Run	Standard function
MPG Simulation	Standard function
Single Block	Standard function
JOG Feed	Standard function
Return to Origin Point (Reference) Position	Standard function
Manual Handle Feed	1 Unit / Each Path
Manual Handle Feed Rate	X1, X10, X100
Program Protect	Standard function

Specifications - CNC Controller Specifications

Interpolation

Positioning	G00
Exact Stop Mode	G61
Exact Stop	G09
Linear Interpolation	G01
Circular Interpolation	G02, G03(multi-quadrant is possible),
Dwell	G04
Skip Function	G31
Reference Position Return	G28
Reference Position Return Check	G27
2ND Reference Position Return	G30

Feed Function

High Speed Moving Override	F0, 25%, 50%, 100%
Cutting Feed Rate Per Minute	F (mm / min)
Cutting Feed Rate Per Minute	Max. Cutting Feed Rate mm/min
Cutting Feed Override	0~150%(Can be defined)
Jog Override	0~100%
Preview Control	500 blocks

Programs and Data Port Input

Optional Dwell	M01
Absolute/Gain Program	G90/G91
Automatic Coordinate Setup System	Automatic Coordinate Setup System
Workpiece Coordinate System	G52, G53, G54~G59
Sub-program Call	Max. 8 layers embedded
Program Start/ Program End	M00 / M01 / M02 / M30
Code format	Standard ISO G, M, S, T codes
Program Flow Control	Internal/External program call, program cycle
Fixed Cycle	Rigid tapping, boring and drilling
Reset	Standard function
On Board I/O	I/O 1 16IN / 16OUT ; I/O 2 12IN / 12OUT
MPG I/O Port	1 set of hand-wheel pulse input
USB Port/RS485/Ethernet	standard function
Origin Point Limit Port	1~4 AXIS + - hardware limit and origin point input
Spindle Port	1 set of analog output DC-10V~+10V/G31/ 1 set of spindle feedback input
High Speed Serial I/O Port	Max. 32IN/32OUT. Extension available for up to 8 sets of 265IN/256OUT

Specifications - CNC Controller Specifications

Spindle Speed and Tool Function

MST Overpass	Standard function
MST Control	Standard function
Spindle Speed Function	S RPM (revolutions per minute)
Spindle Override	50~120%
M Code Function	M3 digit (Example: M003)
S Code Function	S5 digit (Example: S10000)
T Code Function	T2 digit (Example: T01)
Tool Capacity	Max. 100 tools
Tool Length Compensation	G43, G44, G49
Tool Radius Compensation	G41, G42, G40

Setup and Display Function

Mode Display	Automation/Edit/MDI/Hand-wheel/Jog/Origin point
Current Position Display	Program coordinate, mechanical coordinate, remain coordinate, relative coordinate
Software Operation Display	Standard function
G Code Group Display	Standard function
Customized Screen Display	PC editing software needed
Parameters Display Setup	Standard function
Self-diagnosis Function	Standard function
Alarm Display	Standard function
Alarm History Display	512 records
Actual Cutting Feed Speed Rate Display	Standard function
Spindle Speed and T Code Display	Standard function
Parameters Setup Screen	Standard function
Servo Tuning Screen	Standard function
System Information Display	Standard function
Multi-languages Display	Standard function Standard function (switch between Mandarin and English available)
Password Setup	Standard function
Servo Load Rate Display	Standard function
Tool Path Graphics Function	Standard function
Color LCD Display	8" LCD display/10.4" LCD display



Specifications - Servo Motor Specifications (ECMC Series)

Watt	400W	750W	1kW																					
Model	ECMC-C10604□S	ECMC-C10807□S	ECMC-E11310□S																					
Rated Torque(N-m)	1.27	2.39	4.77																					
Maximum Torque(N-m)	3.82	7.16	14.3																					
Rated Speed(r/min)	3000	3000	2000																					
Maximum Speed(r/min)	5000	5000	3000																					
Encoder Type	Incremental 20-bit (1280000p/rev)																							
Maximum Current(A)	7.8	15.3	16.8																					
IP Rating	IP65	IP65	IP65																					
Rotor Moment of Inertia/ With Brake (x10 ⁻⁴ kg-m ²)	0.277 / 0.3	1.13 / 1.18	8.41 / 9.14																					
Speed-Torque Curves (T-N Curves)																								
Motor Size mm (With Brake)																								
Motor Frame(mm)	60	80	130																					
Shaft Diameter(mm)	14	19	22																					
Brake Holding Torque [Nt-m(min)]	1.3	2.5	10																					
Brake Power Consumption (at 20°C)[W]	6.5	8.2	19																					
Weight (With Brake) kg	1.6(2.0)	3.0(3.8)	7.0(8.4)																					
Supported Controllers	ASD-A2-0421-N	ASD-A2-0721-N ASD-M-0721-N	ASD-A2-1021-N																					
Description for Optional Selection	<table border="1"> <thead> <tr> <th>Shaft type and oil seal</th> <th>Without brake/ without oil seal</th> <th>With brake/ without oil seal</th> <th>Without brake/ with oil seal</th> <th>With brake/ with oil seal</th> </tr> </thead> <tbody> <tr> <td>Round shaft (with screw holes)</td> <td>A</td> <td>B</td> <td>C</td> <td>D</td> </tr> <tr> <td>Keyway</td> <td>E</td> <td>F</td> <td>G</td> <td>H</td> </tr> <tr> <td>Keyway (with screw holes)</td> <td>P</td> <td>Q</td> <td>R</td> <td>S</td> </tr> </tbody> </table>				Shaft type and oil seal	Without brake/ without oil seal	With brake/ without oil seal	Without brake/ with oil seal	With brake/ with oil seal	Round shaft (with screw holes)	A	B	C	D	Keyway	E	F	G	H	Keyway (with screw holes)	P	Q	R	S
Shaft type and oil seal	Without brake/ without oil seal	With brake/ without oil seal	Without brake/ with oil seal	With brake/ with oil seal																				
Round shaft (with screw holes)	A	B	C	D																				
Keyway	E	F	G	H																				
Keyway (with screw holes)	P	Q	R	S																				

Specifications - Servo Motor Specifications (ECMC Series)

Watt	1.5kW	2kW	3kW																					
Model	ECMC-E11315□S	ECMC-E11820□S	ECMC-F11830□S																					
Rated Torque(N-m)	7.16	9.55	19.1																					
Maximum Torque(N-m)	21.48	28.65	57.29																					
Rated Speed(r/min)	2000	2000	1500																					
Maximum Speed(r/min)	3000	3000	3000																					
Encoder Type	Incremental 20-bit (1280000p/rev)																							
Maximum Current(A)	24.9	33.66	58.2																					
IP Rating	IP65	IP65	IP65																					
Rotor Moment of Inertia/ With Brake ($\times 10^{-4} \text{kg-m}^2$)	11.18 / 11.9	34.68 / 37.86	54.95 / 57.06																					
Speed-Torque Curves (T-N Curves)																								
Motor Size mm (With Brake)																								
Motor Frame(mm)	130	180	180																					
Shaft Diameter(mm)	22	35	35																					
Brake Holding Torque [Nt-m(min)]	10	25	25																					
Brake Power Consumption (at 20°C)[W]	19	20.4	20.4																					
Weight (With Brake) kg	7.5(8.9)	13.5(17.5)	18.5(22.5)																					
Supported Controllers	ASD-A2-1521-N ASD-M-1521-N	ASD-A2-2023-N ASD-M-2023-N	ASD-A2-3023-N																					
Description for Optional Selection	<table border="1"> <thead> <tr> <th>Shaft type and oil seal</th> <th>Without brake/ without oil seal</th> <th>With brake/ without oil seal</th> <th>Without brake/ with oil seal</th> <th>With brake/ with oil seal</th> </tr> </thead> <tbody> <tr> <td>Round shaft (with screw holes)</td> <td>A</td> <td>B</td> <td>C</td> <td>D</td> </tr> <tr> <td>Keyway</td> <td>E</td> <td>F</td> <td>G</td> <td>H</td> </tr> <tr> <td>Keyway (with screw holes)</td> <td>P</td> <td>Q</td> <td>R</td> <td>S</td> </tr> </tbody> </table>				Shaft type and oil seal	Without brake/ without oil seal	With brake/ without oil seal	Without brake/ with oil seal	With brake/ with oil seal	Round shaft (with screw holes)	A	B	C	D	Keyway	E	F	G	H	Keyway (with screw holes)	P	Q	R	S
Shaft type and oil seal	Without brake/ without oil seal	With brake/ without oil seal	Without brake/ with oil seal	With brake/ with oil seal																				
Round shaft (with screw holes)	A	B	C	D																				
Keyway	E	F	G	H																				
Keyway (with screw holes)	P	Q	R	S																				

Specifications - Servo Drive Specifications (ASDA-A2 Series)

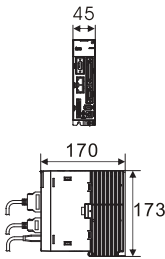
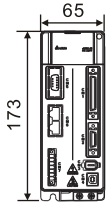
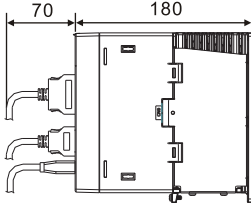
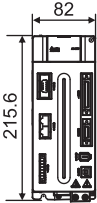
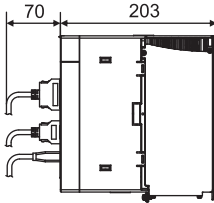
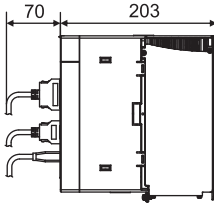
Models	ASD-A2-0421-N	ASD-A2-0721-N	ASD-A2-1021-N	ASD-A2-1521-N	ASD-A2-2023-N	ASD-A2-3023-N
Phase/Voltage	Three-phase or one phase 220VAC				Three-phase 220VAC	
Permissible Voltage Range	Three-phase/one phase 200~230VAC, -15%~10%				Three-phase 200~230VAC, -15%~10%	
Continuous Output Current	2.6Arms	5.1Arms	7.3Arms	8.3Arms	13.4Arms	19.4Arms
Cooling System	Natural Cooling	Fan Cooling				
Encoder Resolution/ Feedback Resolution	20-bit(1280000p/rev)					
Main Circuit Control	SVPWM control					
Regenerated Brake	None	Built-in				
Controller Size (mm)						
Weight (kg)	1.5	2			2.89	

Specifications - Servo Drive Specifications (ASDA-M Series)

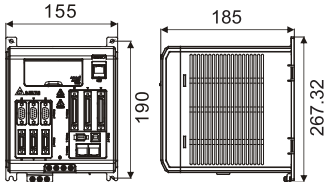
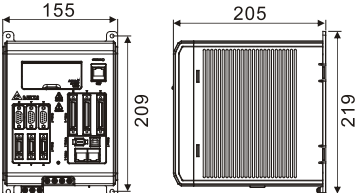
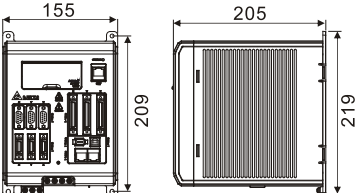
Models	ASD-M-0721-N	ASD-M-1521-N	ASD-M-2023-N
Phase/Voltage	Three-phase or one phase 220VAC		Three-phase 220VAC
Permissible Voltage Range	Three-phase/one phase 200~230VAC, -15%~10%		Three-phase 200~230VAC, -15%~10%
Continuous Output Current	5.1Arms	8.3Arms	13.4Arms
Cooling System	Fan Cooling		
Encoder Resolution/ Feedback Resolution	20-bit(1280000p/rev)		
Main Circuit Control	SVPWM control		
Regenerated Brake	Built-in		
Controller Size (mm)			
Weight (kg)	1.5	2.0	

Specifications - PM Spindle Motor Specifications (ECMS Series)

Watt	3.7kW	6.7kW
Model	ECMS-AM1540□S	ECMS-AM1570□S
Rated Torque(N-m)	5.89	10.66
Maximum Torque(N-m)	14.72	26.65
Rated Speed(r/min)	6000	6000
Maximum Speed(r/min)	12000	12000
Encoder Type(A)	Incremental 20-bit (1280000p/rev), Precision:1/16384 rev	
Rated Current	16.52	27.47
Maximum Current(A)	41.3	68.68
IP Rating	IP55	IP55
Rotor Moment of Inertia/ With Brake ($\times 10^{-4} \text{kg}\cdot\text{m}^2$)	12.3	19.2
Speed-Torque Curves (T-N Curves)		
Motor Frame(mm)		
Motor Frame(mm)	155	155
Shaft Diameter(mm)	28	28
Weight (With Brake) kg	20	27.4
Supported Controllers	ASD-S-4523-N	ASD-S-5523-N
Description for Optional Selection	A (Round Shaft) B (Round Shaft with Coolant Through Spindle)	

Specifications - Spindle Motor Drive Specifications (ASDA-S Series)

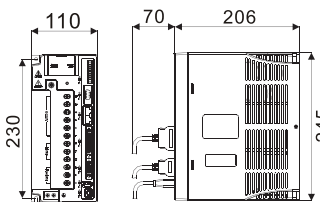
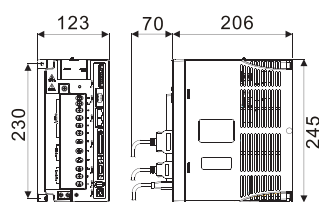
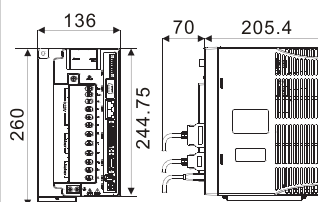
Models	ASD-S-4523-N	ASD-S-5523-N	ASD-S-7523-N
Supported Motors	Delta ECMS-AM1540□S / Induction motors sold on the market (4.5KW, 32.5Arms and under)	Delta ECMS-AM1570□S / Induction motors sold on the market (5.5KW, 40.0Arms and under)	Induction motors sold on the market (7.5KW, 47.5Arms and under)
Permissible Voltage Range	Three-phase 220VAC		
Allowable Voltage Change Rate	Three-phase/one phase 200~230VAC, -15%~10%		
Cooling System	32.5Arms	40.0Arms	47.5Arms
Encoder Resolution/ Feedback Resolution	Fan Cooling		
Main Circuit Control	SVPWM control		
Regenerated Brake	Built-in	Break resistor needed or select Delta C-BOX(ASD-MDCP2016)	
Controller Size (mm)			
Weight (kg)	4.4	5.5	5.9

Overload Characteristics

Overload Protection Definition

- Overload protection prevents motors from overheating.

Overload Reasons

- Motor operation exceeds rated torque. Continuous operation for too long.
- Extremely high inertia ratio and excessive acceleration/deceleration operations
- Incorrect connection between power line and encoder
- Incorrect servo gain setup that produces motor resonance
- The brake is not released during operation (for motors with brakes)

Chart of Load and Operating Time

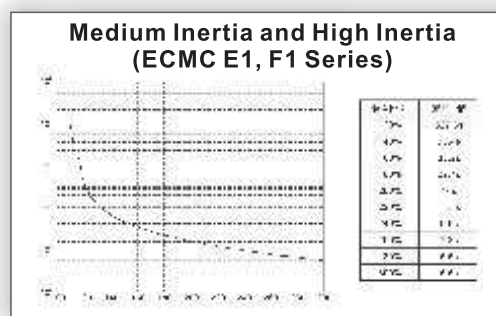
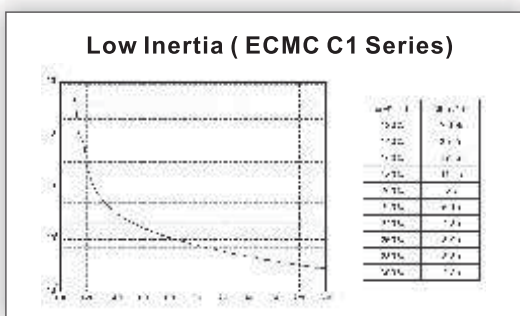

Specifications - Electrical Specifications

Models	NC300A	NC311A
Operation Environment	10% ~ 95% RH 【0 ~ +55°C】	
Storage Environment	10% ~ 95% RH 【-20~ +60°C】	
Cooling Method	Natural Cooling	
Safety Approval	CE	
Operation Voltage	DC +24V (-10% ~ +15%) (has built-in isolated power circuit)	
Voltage Endurance	AC500V for 1 minute (between charging (DC24V terminal) and FG terminals)	
Power Consumption	24V 0.6A 15W	24V 0.8A 20W
Backup Battery	3V lithium manganese battery Cr2032x1	
Backup Battery Life	It depends on the temperature used and the condition of usage, about 3 years or more at 25°C	
Weight(kg)	MI : 4.16 ; MS : 3.1	3.8



Dimensions - CNC Controller

NC300A-MI-A

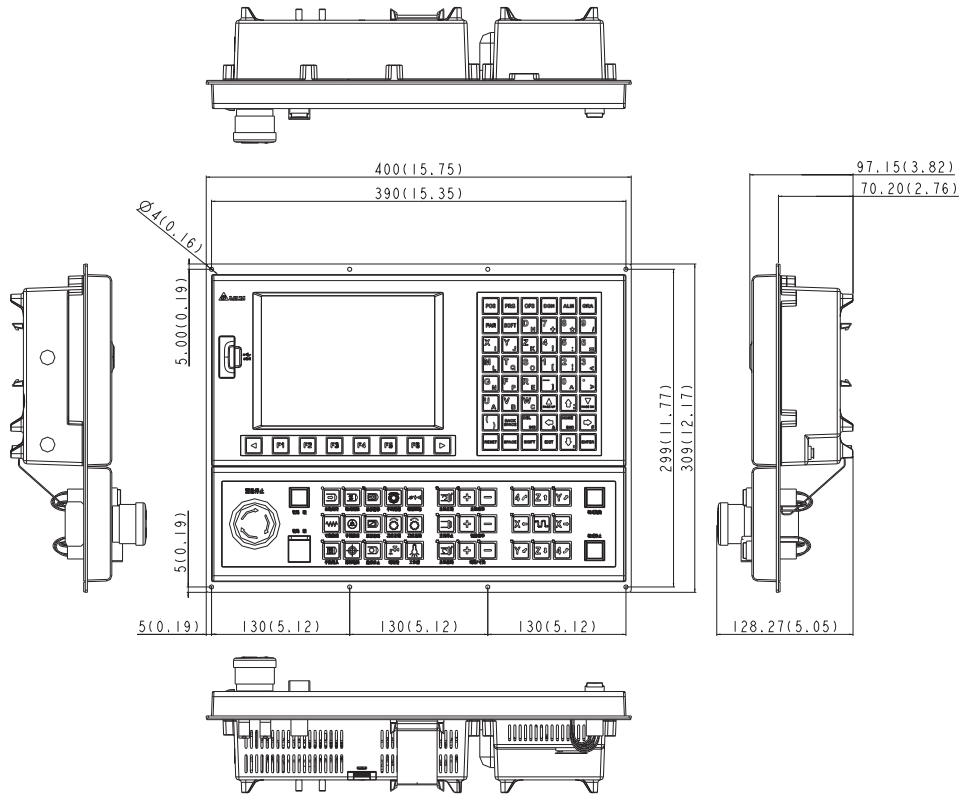

Panel Cutout

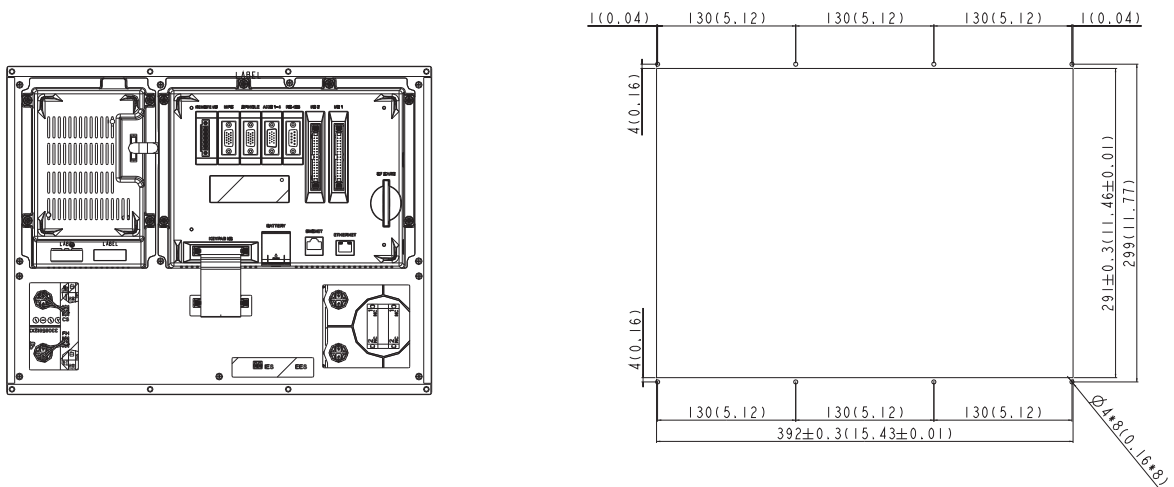

UNITS:mm(inch)

Dimensions

Dimensions - CNC Controller

NC300A-MS-A

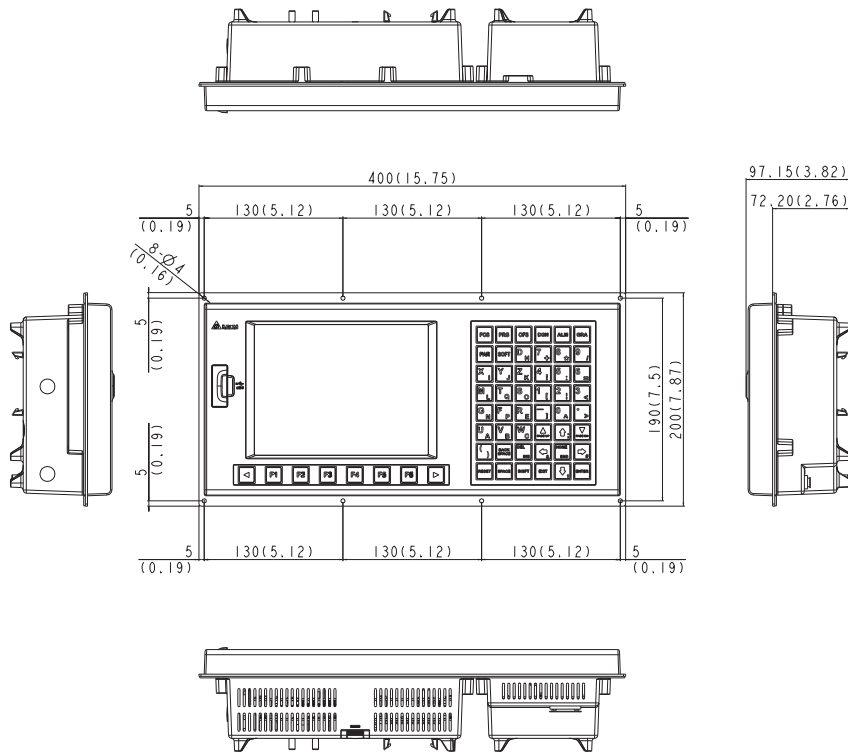

Panel Cutout

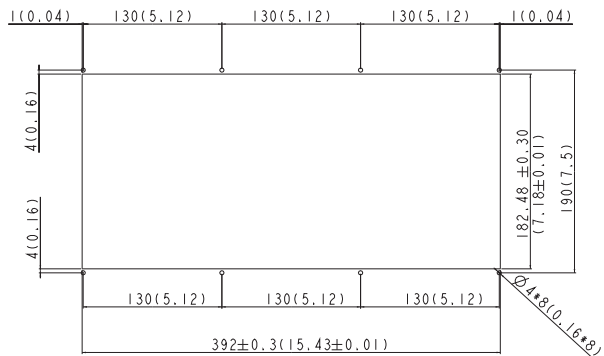
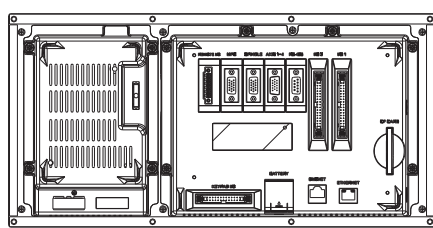

UNITS:mm(inch)

NC311A-MS-A

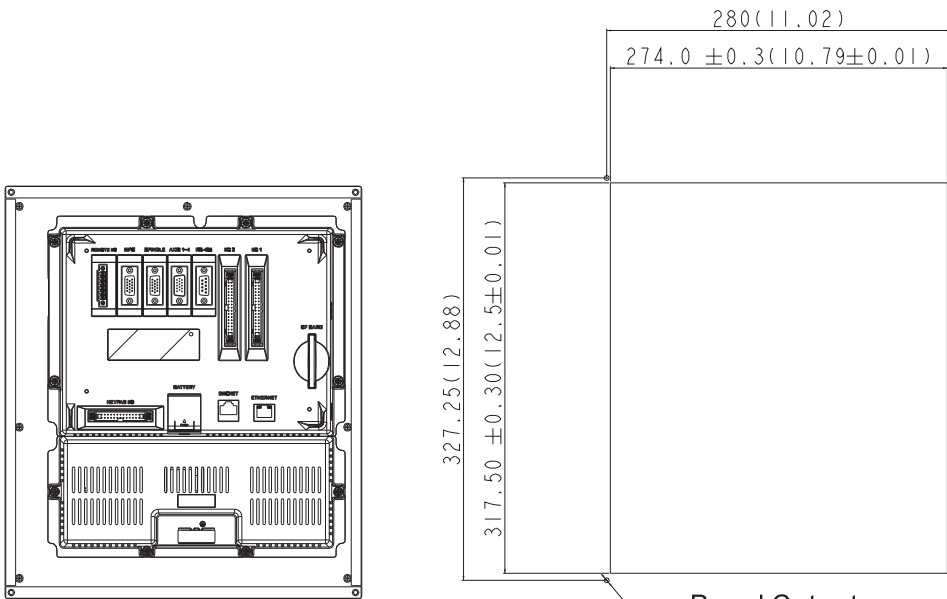
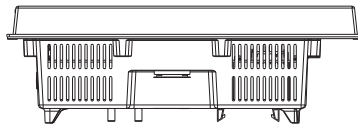
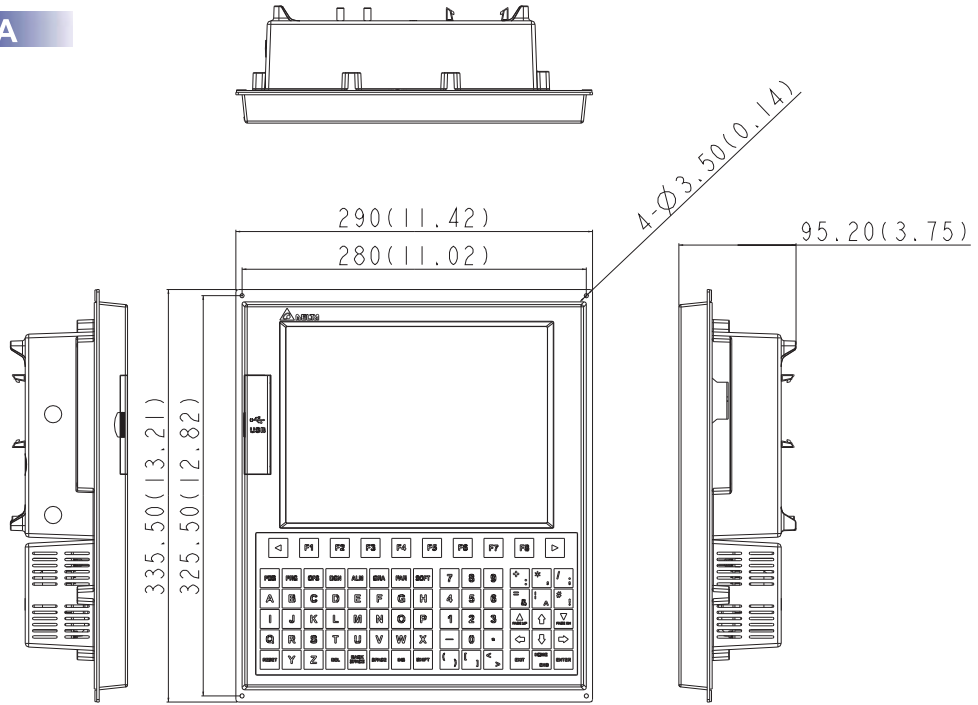

UNITS:mm(inch)

Optional Accessories - CNC Second Operation Panel

Membrane Type Operation Panel for Milling Machines

NC-PAN-300AM-F



- **Size:**
400mm x 200mm x 71.08mm
(Length x Width x Total Height)

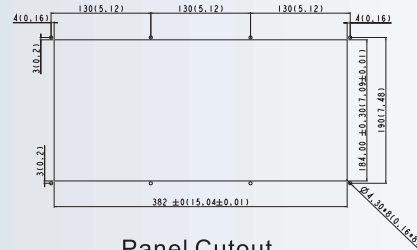

Panel Cutout

Key Type Operation Panel for Milling Machines

NC-PAN-300AM-P



- **Size:**
400mm x 200mm x 92.16mm
(Length x Width x Total Height)

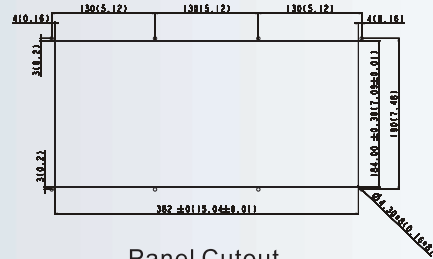

Panel Cutout

Key Type Operation Panel for High Speed Tapping Machines

NC-PAN-311AM-P



- **Size:**
290mm x 250mm x 92.23mm
(Length x Width x Total Height)

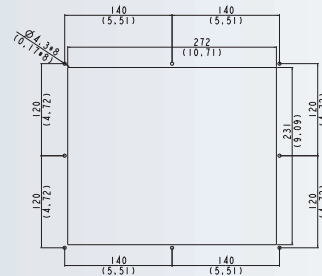

Panel Cutout

CNC Second Panel Terminal Block Module



- **Supports 56IN/56OUT**
- **Part No.**
NC-TBM-P5656
- **Size:**
63.25mm x 120.8mm x 53.9mm
(Length x Width x Total Height)

Optional Accessories - Cables and Terminal Blocks

Local I/O

I/O Cable



- Supports 1.5/3.0/5.0/10M
- Part No.
1.5M, NC-CAB-TBM015
3.0M, NC-CAB-TBM030
5.0M, NC-CAB-TBM050
10M, NC-CAB-TBM100

Local I/O



- Supports 16IN/16OUT
- Part No.
NC-TBM-T1616
- Size:
146.25mm x 86.71mm x 52.81mm
(Length x Width x Total Height)

Relay I/O



- Supports 16IN/16OUT
- Part No.
NC-TBM-R1616
- Size:
286mm x 121.78mm x 54.73mm
(Length x Width x Total Height)

High Speed Serial I/O

Serial Cable



- Supports
1.5/3.0/5.0/10M
- Part No.
1.5M, NC-CAB-EIO015
3.0M, NC-CAB-EIO030
5.0M, NC-CAB-EIO050
10M, NC-CAB-EIO100

Photocoupler Type



- Supports
32IN/32OUT
- Part No.
NC-EIO-T3232
- Size:
286mm x 121.78mm x 51.01mm
(Length x Width x Total Height)

Relay Type



- Supports
32IN/16OUT
- Part No.
NC-EIO-R3216
- Size:
286mm x 121.7mm x 54.73mm
(Length x Width x Total Height)

Relay Type



- Supports
20IN/10OUT
- Part No.
NC-EIO-R2010
- Size:
217mm x 121.79mm x 60.56mm
(Length x Width x Total Height)

Terminal Blocks

DMCNET Line



- Supports
0.3/1.5/3.0/5.0/10M
- Part No.
0.3M, NC-CAB-DMC003
1.5M, NC-CAB-DMC015
3.0M, NC-CAB-DMC030
5.0M, NC-CAB-DMC050
10M, NC-CAB-DMC100

Spindle and 1~4 Axes Terminal Block



- Terminal block for spindle and 1~4 axes
- Part No.
NC-EXM-S01
- Size:
146.25mm x 86.78mm x 51.05mm
(Length x Width x Total Height)

MPG Terminal Block



- Adaptor for MPG
- Part No.
NC-EXM-M01
- Size:
62.50mm x 86.78mm x 51.05mm
(Length x Width x Total Height)



Smarter. Greener. Together.

Industrial Automation Headquarters

Delta Electronics, Inc.

Taoyuan Technology Center
No.18, Xinglong Rd., Taoyuan City,
Taoyuan County 33068, Taiwan
TEL: 886-3-362-6301 / FAX: 886-3-371-6301

Asia

Delta Electronics (Jiangsu) Ltd.

Wujiang Plant 3
1688 Jiangxing East Road,
Wujiang Economic Development Zone
Wujiang City, Jiang Su Province,
People's Republic of China (Post code: 215200)
TEL: 86-512-6340-3008 / FAX: 86-769-6340-7290

Delta Greentech (China) Co., Ltd.

238 Min-Xia Road, Pudong District,
Shanghai, P.R.C.
Post code : 201209
TEL: 86-21-58635678 / FAX: 86-21-58630003

Delta Electronics (Japan), Inc.

Tokyo Office
2-1-14 Minato-ku Shibadaimon,
Tokyo 105-0012, Japan
TEL: 81-3-5733-1111 / FAX: 81-3-5733-1211

Delta Electronics (Korea), Inc.

1511, Byucksan Digital Valley 6-cha, Gasan-dong,
Geumcheon-gu, Seoul, Korea, 153-704
TEL: 82-2-515-5303 / FAX: 82-2-515-5302

Delta Electronics Int'l (S) Pte Ltd

4 Kaki Bukit Ave 1, #05-05, Singapore 417939
TEL: 65-6747-5155 / FAX: 65-6744-9228

Delta Electronics (India) Pvt. Ltd.

Plot No 43 Sector 35, HSIIDC
Gurgaon, PIN 122001, Haryana, India
TEL : 91-124-4874900 / FAX : 91-124-4874945

Americas

Delta Products Corporation (USA)

Raleigh Office
P.O. Box 12173, 5101 Davis Drive,
Research Triangle Park, NC 27709, U.S.A.
TEL: 1-919-767-3800 / FAX: 1-919-767-8080

Delta Greentech (Brasil) S.A

Sao Paulo Office
Rua Itapeva, 26 - 3° andar Edificio Itapeva One-Bela Vista
01332-000-São Paulo-SP-Brazil
TEL: +55 11 3568-3855 / FAX: +55 11 3568-3865

Europe

Deltronics (The Netherlands) B.V.

Eindhoven Office
De Witbogt 15, 5652 AG Eindhoven, The Netherlands
TEL: 31-40-2592850 / FAX: 31-40-2592851

*We reserve the right to change the information in this catalogue without prior notice.