



Features

- Totally self-contained miniature sensors
- 10 to 30V dc operation
- Visible red sensing beam
- Up to 1.0 m (39") sensing range
- Choose dark or light operate models
- Choose models with NPN (sinking) or PNP (sourcing) output
- 2-wire and 3-wire hookup; output load capacity to 50 mA
- Choice of integral cable or quick-disconnect pigtail

VS4 Series miniature self-contained sensors are designed for precision sensing in narrow areas previously accessible only to remote or fiber optic models. Typical applications include mounting inside small conveyors and electronic component handling equipment.



Visible red, 660 nm

Models

Models	Sensing Range	Cable	Supply Voltage	Output Type	Excess Gain	Beam Pattern
VS4EV	1.0 m (39")	2 m (6.5') 2 wire	10 to 30V dc	-		
VS4EVQ		3-pin pico Pigtail QD				
VS4AN5R		2 m (6.5') 3 wire		NPN/LO		
VS4AN5RQ		3-pin pico Pigtail QD				
VS4RN5R		2 m (6.5') 3 wire		NPN/DO		
VS4RN5RQ		3-pin pico Pigtail QD				
VS4AP5R		2 m (6.5') 3 wire		PNP/LO		
VS4AP5RQ		3-pin pico Pigtail QD				
VS4RP5R		2 m (6.5') 3 wire		PNP/DO		
VS4RP5RQ		3-pin pico Pigtail QD				



WARNING . . . Not To Be Used for Personnel Protection

Never use these products as sensing devices for personnel protection. Doing so could lead to serious injury or death.

These sensors do NOT include the self-checking redundant circuitry necessary to allow their use in personnel safety applications. A sensor failure or malfunction can cause either an energized or de-energized sensor output condition. Consult your current Banner Safety Products catalog for safety products which meet OSHA, ANSI and IEC standards for personnel protection.

VS4 Series – Opposed-Mode Sensors

Specifications

Supply Voltage and Current	10 to 30V dc (10% maximum ripple) Emitter: 25 mA Receiver: 25 mA (exclusive of load)
Supply Protection Circuitry	Protected against reverse polarity and transient voltages
Output Configuration	SPST solid-state switch Choose NPN (current sinking) or PNP (current sourcing), depending on model Choose light operate (N.O.) or dark operate (N.C.), depending on model
Output Rating	50 mA maximum Off-state leakage current: < 1 microamp at 24V dc On-state saturation voltage: < 0.25V at 10 mA dc; < 0.5V at 50 mA dc
Output Protection Circuitry	Protected against false pulse on power-up -and continuous overload or short circuit of outputs Overload trip point 100 mA
Output Response Time	1 millisecond ON and 0.5 milliseconds OFF (NOTE: 100 millisecond delay on power-up: output is non-conducting during this time)
Repeatability	100 microseconds
Indicators	Two LEDs: Green and Yellow Green ON steady: power to sensor is ON Green flashing: output overload Yellow ON steady: light is sensed Yellow flashing: marginal excess gain (1 to 1.5x) in light condition
Construction	Polycarbonate mounting holes and lens Low pressure molded thermoplastic housing (UL 94-V0)
Environmental Rating	IP67; NEMA 6
Connections	2 m (6.5') attached cable: three #28 ga stranded conductors with PE insulation; PVC outer cable jacket; or 3-pin Pico-style pigtail quick-disconnect fitting. QD cables are ordered separately.
Operating Conditions	Temperature: -20° to +55° C (-4° to +131° F) Maximum Relative Humidity: 80% at 50° C (non-condensing)
Vibration and Mechanical Shock	Vibration: All models meet IEC 60068-2-6, IEC 60947-5-2, UL491 Section 40, MIL-STD-202F Method 201A; 10 to 60 Hz, 0.5 mm peak to peak Shock: All models meet IEC 60068-2-27, IEC 60947-5-2; 30g peak acceleration, 11 millisecond pulse duration, half-sine wave pulse shape
Application Notes	M2 stainless steel mounting hardware included. Optional mounting bracket available (page 4).
Certifications	

VS4 Series – Opposed-Mode Sensors

Dimensions

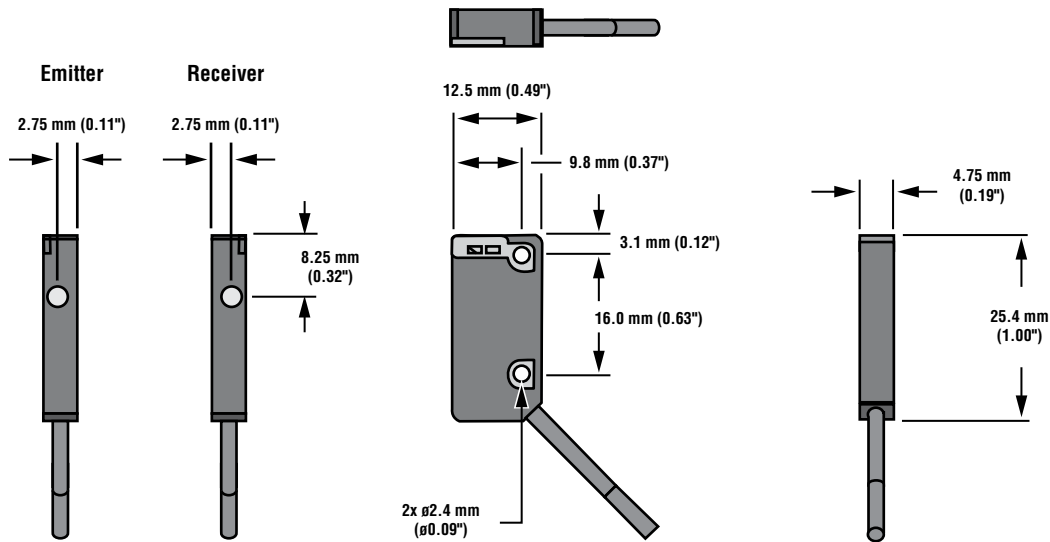

Hookups

Emitters with Cable

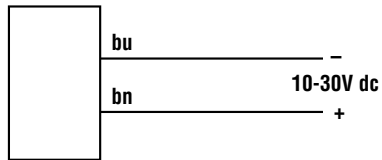

Emitters with Quick-Disconnect

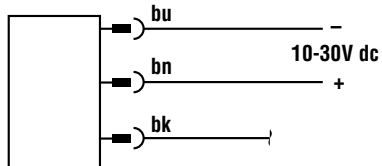

NPN Models with Cable

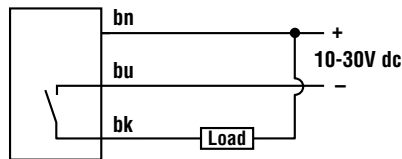

NPN Models with Quick-Disconnect

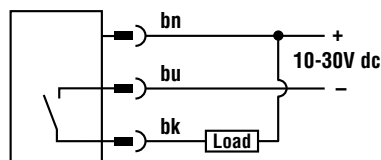

PNP Models with Cable

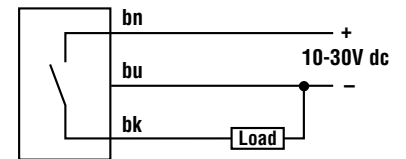

PNP Models with Quick-Disconnect

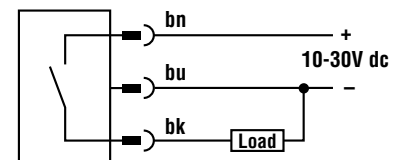

Accessories

Quick-Disconnect (QD) Cables

Style	Model	Length	For Use With	Dimensions	Pinout
3-pin Pico Style Straight	PKG3M-2 PKG3M-9	2 m (6.5') 9 m (30')	All VS4 Series sensors with model suffix "Q"		

VS4 Series – Opposed-Mode Sensors

Accessories

Apertures

APVS4-0206

- 2-holed aperture
- 0.020" and 0.060" diameter holes

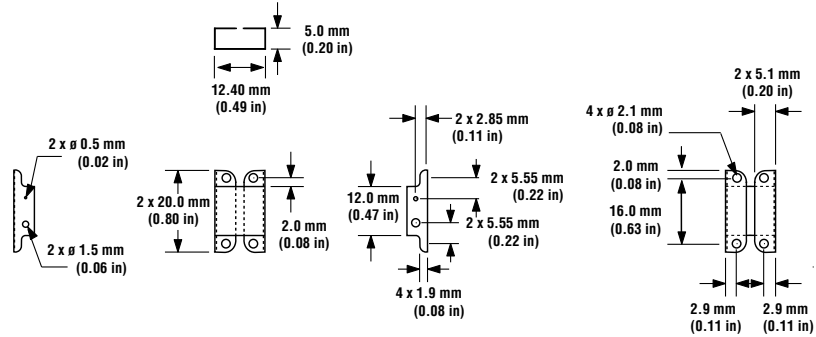

APVS4-0408

- 2-holed aperture
- 0.040" and 0.080" diameter holes

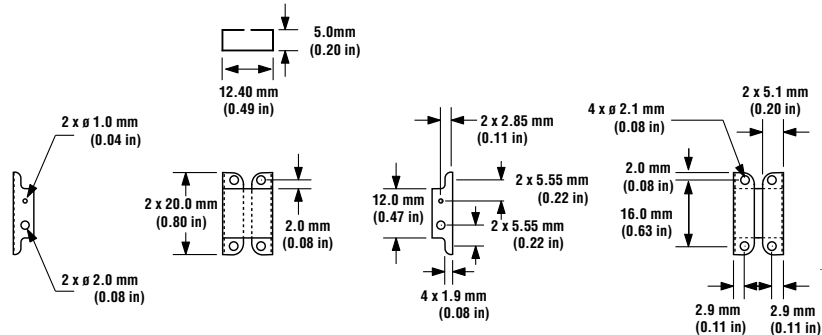

Mounting Brackets

SMBVS4SRA

- Right-angle bracket
- 300 series stainless steel

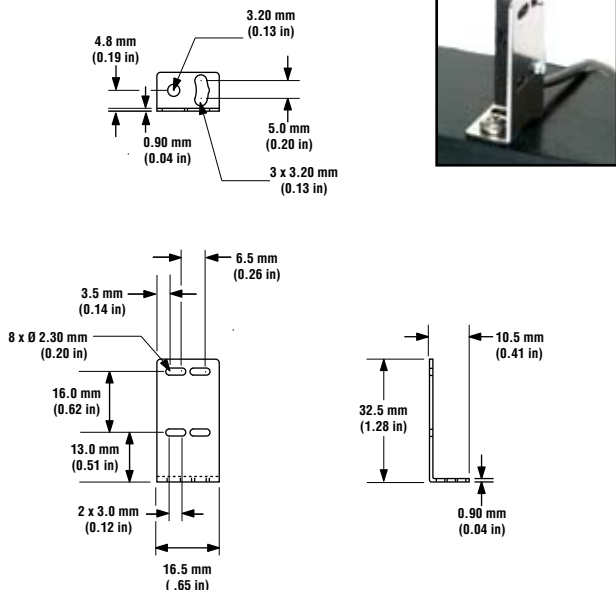

WARRANTY: Banner Engineering Corp. warrants its products to be free from defects for one year. Banner Engineering Corp. will repair or replace, free of charge, any product of its manufacture found to be defective at the time it is returned to the factory during the warranty period. This warranty does not cover damage or liability for the improper application of Banner products. This warranty is in lieu of any other warranty either expressed or implied.